

# VARIABLE CAPACITY COMMERCIAL INVERTER PACKAGE DUCTED UNITS PKV720T-960T

Installation and Commissioning Guide



## Model Numbers

PKV720T

PKV850T

PKV960T

### **IMPORTANT NOTE:**

Please read this manual carefully before installing or operating your air conditioning unit.



## Table of Contents

<b>Introduction</b> .....	<b>4</b>
<b>General Information</b> .....	<b>5</b>
<b>Safety Instructions</b> .....	<b>7</b>
<b>Installation Information</b> .....	<b>8</b>
<b>Operation Manual Access</b> .....	<b>9</b>
<b>Wall Controller Options</b> .....	<b>10</b>
Wall Controller Options	10
Wiring Configuration : Recommended	11
Wiring Configuration : Alternate	12
<b>Unit Mounting and Location</b> .....	<b>13</b>
<b>Components Overview</b> .....	<b>14</b>
<b>Electrical Control Panel</b> .....	<b>15</b>
PKV720T	15
PKV850T / PKV960T	16
Group Control Option Electrical Board Layout	17
BMS Option Electrical Board Layout	18
Unit Dimensions, Clearances and Weights	19
PKV720T	19
PKV850T / PKV960T	20
Service Clearances and Airflow Allowances	21
Unit Base Dimensions	22
<b>Banking of Units</b> .....	<b>23</b>
End-To-End Configuration	23
Cluster Configuration	23
Side-By-Side Configuration	24
End-To-End Configuration (With Optional Hood) ***	24
<b>Unit Lifting Procedures</b> .....	<b>25</b>
Crane Lifting Method	25
Forklift Method	26
<b>Unit Preparation</b> .....	<b>27</b>
<b>Air Filter Installation</b> .....	<b>28</b>
<b>Electrical Installation</b> .....	<b>29</b>
<b>Electrical Connection</b> .....	<b>30</b>
<b>Circuit Breaker Size Recommendation</b> .....	<b>31</b>
<b>Wiring Connections</b> .....	<b>32</b>
LR7-1 and LC7-2 Wall Control Wiring Connections	32
NEO Wall Control Wiring Connections	32
LM-RS-2 Optional Sensor Wiring Connections	33
AERSS Optional Duct Sensor Wiring Connections	33
<b>Wiring Diagram - PKV720T</b> .....	<b>34</b>
<b>Wiring Diagram - PKV850T</b> .....	<b>35</b>
<b>Wiring Diagram - PKV960T</b> .....	<b>36</b>

## Table of Contents

<b>Configuring and Commissioning Setup</b> .....	<b>37</b>
Menu and Navigation	37
Configuring Compressor and Capacity(cnFg)	38
Configuring Control Source (CtrS)	38
<b>Optional BMS Control</b> .....	<b>39</b>
<b>Accessing Service and Technical via NEO</b> .....	<b>40</b>
<b>After Hours Logic with Timeclock (Scheduler)</b> .....	<b>42</b>
<b>Filter Alarm Configuration</b> .....	<b>45</b>
Filter Alarm Configuration	45
<b>Indoor Drain Pan Overflow Sensor</b> .....	<b>46</b>
<b>SETTING ECONOMY CYCLE OPERATION</b> .....	<b>48</b>
<b>Bluetooth Commissioning Tool</b> .....	<b>57</b>
<b>Demand Response Management</b> .....	<b>58</b>
<b>Third Party Control Input (Indoor and/or Outdoor Board)</b> .....	<b>59</b>
0-10V Analogue Input for Compressor and Indoor Fan	59
0-10V Analogue Input for Compressor with Fixed Indoor Fan Speed	60
Input for Fixed Compressor with Fixed Indoor Fan Speed	61
0-10V Analogue Input for Indoor Fan with Fixed Speed Compressor	61
Run and Fault Indication Output (Outdoor Board)	62
Remote On/Off	63
<b>Fan Performance Data and Curve</b> .....	<b>64</b>
PKV720T	64
PKV850T	66
PKV960T	68
<b>SENSOR DETAIL</b> .....	<b>70</b>
<b>Refrigerant Charging</b> .....	<b>71</b>
Charging Method: Subcooling and Superheat	71
<b>Fault Display Codes</b> .....	<b>74</b>
Outdoor Board Fault Display Codes	74
<b>Maintenance</b> .....	<b>77</b>
<b>Maintenance Frequency Checklist</b> .....	<b>79</b>
<b>Start Up and Commissioning Report</b> .....	<b>81</b>
<b>Version History</b> .....	<b>82</b>

## Introduction

**CONGRATULATIONS** on your purchase of an ActronAir air conditioning system! This unit has been designed and engineered to provide optimum air conditioning and to achieve maximum energy efficiency.

Your air conditioning system has been manufactured from the highest quality materials. Numerous “in house” and “external” inspection and test procedures were conducted to your air conditioner to ensure satisfactory operation.

### Information About This Guide

This guide provides installation instructions, specific to your ducted unit. Read this manual thoroughly and take into consideration all specifications and instructions to ensure correct installation and safe operation of your air conditioning system.

#### NOTE

Print a copy of this document and keep it for future reference. Ensure all technicians that work on the unit can refer to this manual at any time.

### Product Inspections

Check your air conditioning unit and all items against the invoice upon receiving your shipment. Inspect the unit, components and accessories for any sign of damage. If there is any damage to the unit, contact ActronAir Customer Care Department immediately on: **1300 522 722** to obtain a Goods Return Number.

Check the unit nameplate to verify the model, serial number, electrical rated specifications are correct.

### Codes, Regulations And Standards

The installer and/or contractor assumes responsibility to ensure that unit installation complies with the relevant council, state / federal codes, regulations and building code standards. All electrical wiring must be in accordance with current electrical authority regulations and all wiring connections to be as per electrical diagram provided with the unit

### Important Safety Symbols And Labels

Safety Symbols and labels appear at appropriate sections throughout this manual to indicate immediate or potential hazards. Pay full attention and comply to the safety information and instructions. Failure to follow safety instructions increases the risks of personal injury, death and/or property damage. Damages to the product as a result of such failure may void warranty.

ActronAir has endeavoured to provide sufficient safety warnings and recommendations, however current and prevailing WH&S regulations must be observed and will take precedent whenever performing the installation instructions discussed in this manual.



## General Information

ActronAir air conditioning units are designed for applications where superior performance, high efficiency, reliability, supply air quality and quiet operation are the prime priorities. The units are built with the latest technologies advanced variable speed driven inverter compressor, EC outdoor/indoor fans, low-noise outdoor fans, electronic expansion valve and an intelligent electronic control.

For optimum efficiency, your air conditioning unit will deliver just the right amount of cooling or heating capacity.

### Energy Efficient Refrigeration Circuits

The ActronAir system is designed with a highly efficient refrigeration circuit that delivers only the amount of cooling or heating actually required to maintain your desired comfort at the most optimum efficiency.

Each refrigeration circuit consists of:

- High efficiency variable capacity scroll compressor with individual compressor drive
- Hydrophilic coated condenser coil designed for optimum performance and efficiency with corrugated fins and ruffled tubing
- Hydrophilic coated evaporator coil designed for optimum performance and efficiency with lanced fins and ruffled tubing
- Electronic expansion valve (EEV), to maintain efficiency at across a wide range of operating conditions

### Evaporator Section

The evaporator section has EC fans which deliver just the right amount of airflow, depending on requirements. The fans provide superior performance for your comfort at optimum efficiency:

- Highly efficient variable speed EC motor that uses less energy than the traditional fixed speed induction motor
- Easy indoor fan commissioning via intelligent controllers
- Low noise operation
- Adjustable Indoor Airflow

### Condenser Section

Uses two (3) EC axial fans and state of the art Inverter Compressor, with the following features:

- Efficient Tru-Inverter Compressor and Inverter Drive combination
- Efficient axial fans with direct drive EC motor
- Low noise operation
- Variable compressor capacity
- Variable speed outdoor fan

### Electrical Section

The electrical section is composed of a panel for controls, protecting the components from the elements and a separate panel enclosure for the variable speed drive.

### Durable Design and Construction

ActronAir is an Australian manufacturer with proven high quality air conditioning products. Known for their durability and reliable performance, these products are designed and built to withstand the extreme Australian weather conditions.

The galvanized steel cabinet, with powder coated epoxy enamel finish, resists the toughest conditions. The louvered outdoor coil guard protects the condenser coil from any potential damage brought by hail, stones and other solid objects that may be projected to the unit.

Blue Hydrophilic coil fins provide protection to your heat exchangers and enhanced heat transfer with increased performance efficiency.

External fasteners in all Outdoor and Package unit are stainless steel screws Gem-Cote coating.

### System Flexibility

The ActronAir Variable Capacity range air conditioning units are the first choice for residential and commercial applications, both for new construction or retrofitting projects.

## **Refrigerant Handling and Accountability**

ActronAir strongly urges that all service technicians make every effort possible to eliminate and/or vigorously reduce the emission of refrigerants to the atmosphere. Everyone must act in a responsible manner to conserve refrigerants in accordance to the industry code of practice.

## **Sustainability and Environmentally Friendly**

The air conditioning system is supplied with zero ozone depleting refrigerant, which has no phase out or replacement concern.

With cooling and heating performance capacity that are among the best in the market, the ActronAir air conditioning units provide the solution for the reduction of energy consumption, CO<sub>2</sub> emission, high fuel dependency and high network grid demand.

## Safety Instructions

- Only licensed HVAC technicians\* should install and service air conditioning equipment. Improper service or alteration by an unqualified technician could result in significant and major damage to the product or property which may render your warranty null and void. Such unqualified service could also lead to severe physical injury or death. Follow all safety instructions in this literature and all warning labels that are attached to the equipment.
- Prevailing WH&S regulations must be observed and will take precedence to the safety instructions contained on this manual. Safe work practices and environment must be the paramount importance in the performance of all the service procedures.
- Ensure that unit installation complies with relevant council regulations and building code standards.
- All electrical wiring must be in accordance with current electrical authority regulations and all wiring connections to be as per electrical diagram provided.
- Secure the fans against accidental contact. Beware of pinch point and sharp edges which can cause cutting injury.
- Always wear appropriate PPE, remove any dangling jewelery and protect long hair by wearing a cap.
- Make sure that safety guards and panel covers are always firmly secured and not damaged before and during operation of unit.
- This appliance is not intended for use by young children or infirm persons unless they have been adequately supervised by a responsible person to ensure that they can use the appliance safely. Young children should be supervised to ensure that they do not play with the appliance.
- Installer must incorporate a means of electrical disconnection (isolator) in the sub mains fixed wiring in accordance with the latest edition of the AS/NZS 3000 (also known as Australian Wiring Rules).
- Secure the power cords and control cables that goes in/out the unit. Use the cable ties provided in the control box.

\*Qualifications required will be appropriate Electrical, Refrigeration and Refrigerant Handling License and Training dependent on local State/Territory regulations.

### DANGER

#### **Hazardous Voltage - Risk of Electrocutation.**

TURN-OFF the power from main isolator before proceeding with any service work of the unit. Observe proper LOCK-OUT/TAG-OUT (LOTO) procedures for electrical appliances in order to prevent accidental switching-on of the power supply.

### WARNING

EC Motors and Compressor Drives are fitted with high power capacitors and can have dangerous residual voltages at motor/drive terminals after power has been isolated. Wait at least 5 minutes after power isolation and test for any residual voltage before beginning service work.

### CAUTION

#### **Beware of Rotating Fans !**

Ensure that indoor and outdoor fans are isolated and have come to a complete stand still before servicing the equipment. Beware of pinch point and sharp edges which can cause cutting injury. Secure the fans against accidental contact. Always wear appropriate PPE and remove any dangling jewellery and protect long hair by wearing a cap. Ensure that no loose clothing can be caught / entangled in moving parts.

### **VISUAL INSPECTION AND WORK ASSESSMENT**

Work areas and conditions must first be assessed and evaluated for any potential hazardous conditions. It is also important to be familiar with the unit parts and components before proceeding with any service task.

## Installation Information

All service technicians handling refrigerant must be licensed to handle refrigerant gases.

### Recover and Recycle Refrigerants

Never release refrigerant to the atmosphere! It is an offence in Australia to do so. Always recover, recycle and reuse refrigerants. When removing from the system, properly contain and identify refrigerants in its dedicated container for proper disposal and/or storage. Always consider the recycle or reclaim requirements of the refrigerant before beginning the recovery procedures. Obtain a chemical analysis of the refrigerant if necessary. For the recovered refrigerant and acceptable refrigerant quality, refer to the existing standards and regulations.

### Refrigerant Handling and Safety

Consult the refrigerant manufacturer's Material Safety Data Sheet (MSDS) for information on proper handling and to fully understand health, safety, storage and disposal requirements. Use the approved containment vessels and refer to appropriate safety standards. Comply with all applicable transportation standards when shipping refrigerant containers.

### Service Equipment and Recovery Procedures

Always use refrigerant reclaiming equipment in order to minimise refrigerant emissions. Use equipment and methods which will pull the lowest possible system vacuum while recovering and condensing refrigerant. Equipment capable of pulling a vacuum of less than 500 microns is required.

Do not open the system to the atmosphere for service work until refrigerant is fully removed and/or recovered. Perform refrigeration system evacuation, prior to charging, in accordance with AIRAH / IRHACE Refrigerant handling code of practice.

Let the unit stand for 1 hour and with the vacuum not rising above 500 microns. A rise above 500 microns indicates a leak from the system and a leak test is required to locate and repair any leak.

### CAUTION

A leak test is always required on any repaired section of the refrigeration system.

Charge refrigerant into the system only after the equipment does not leak or contain moisture. Take into consideration the correct amount of refrigerant charge specified for the system to ensure efficient unit operations. When charging is complete, reclaim refrigerant from charging lines into an approved refrigerant container. Seal all used refrigerant containers with approved closure devices to prevent unused refrigerant from escaping to the atmosphere. Take extra care to maintain all service equipment directly supporting refrigerant service work such as gauges, hoses, vacuum pumps and recycling equipment.

### INSTALLATION PREPARATION (Pre-Installation considerations)

The following items must be considered before beginning the unit installation:

- Verify the unit capacities and ratings with the unit nameplate.
- Make certain the floor or foundation is level, solid and has sufficient structural strength to support the unit and accessories weight.
- Allow minimum recommended clearances for periodic maintenance and service access.
- Allow sufficient space above the unit for the outdoor air discharge. Condenser air inlet, located on the coil side of the unit, requires sufficient airflow clearance for the optimum unit performance.
- Note the conditioned supply air and return air location. Ensure sufficient spaces are allocated for these purposes.
- For the connection and location of condensate drain in the unit, refer to the drawings and dimensions section of this manual.
- Wiring connections must be in accordance with the wiring diagram provided with the unit.
- Make sure all wirings are in accordance with local electricity authority regulations and standards.
- Do not install the unit close to an area where there is a danger of fire due to volatile, explosive, flammable and/or hazardous materials.
- Ensure that spaces around the unit are free from any obstructions for optimum unit performance.

- Installer to ensure correct size/type that main circuit breaker and cable is installed in unit sub-mains to protect the sub-mains and unit wiring.
- Installer to ensure correctly rated residual current device (RCD) is installed as per the latest edition of the AS/NZS 3000 (also known as Australian Wiring Rules).
- Secure the power cords and control cables that goes in/out the unit. Use the cable ties provided in the control box.

 **CAUTION**

This outdoor unit is designed to match only with an ActronAir indoor unit as specified in the Technical Selection Catalogue. The unit is supplied with factory charged refrigerant as stated in the Rating Label. The use of other material as a refrigerant may cause explosion and/or personal injury.

Be aware of all the relevant regulations concerning the handling of refrigerant.

**This unit is charged with R-410A**

Ensure that R-410A is only charged in liquid form.

## Operation Manual Access

**Download from website**

Operation manuals can be downloaded through our website shown below.

<https://actronair.com.au/manuals/>

## Wall Controller Options

### Wall Controller Options

A maximum of three (3) wall controllers in the below combinations is allowed per unit. See below table.

Options	Wall Controllers		
	C1	C2	C3
1st Option	NEO		
2nd Option	NEO	NEO	
3rd Option	NEO	NEO	LR7-1 / LC7-2
4th Option	NEO	LR7-1 / LC7-2	
5th Option	NEO	LR7-1 / LC7-2	LR7-1 / LC7-2
6th Option	LR7-1 / LC7-2		
7th Option	LR7-1 / LC7-2	LR7-1 / LC7-2	
8th Option	LR7-1 / LC7-2	LR7-1 / LC7-2	LR7-1 / LC7-2

#### NOTES

- NEO - Available in White (NTW-1000) and Black (NTB-1000).
- LC7-2, LR7-1 and LM-RS-2 - Available in White and Grey.
- In the instance of a combination of NEO and LR7-1 / LC7-2 being connected together, the NEO will always need to be addressed as C1.

**Wiring Configuration : Recommended**

**NOTES**

- Diagram shown below is a general representation only. Refer to individual unit wiring diagram for complete wiring connection details.
- Long runs beside Mains cables or TV antenna cables should be avoided.
- Wiring configuration for LR7-1 and LC7-2 wall controller is the same.
- Daisy connection is not allowed for the NEO wall controller.
- Two Ferrite Clips\*, if supplied, are to be placed 200mm and 400mm from the NEO controller.

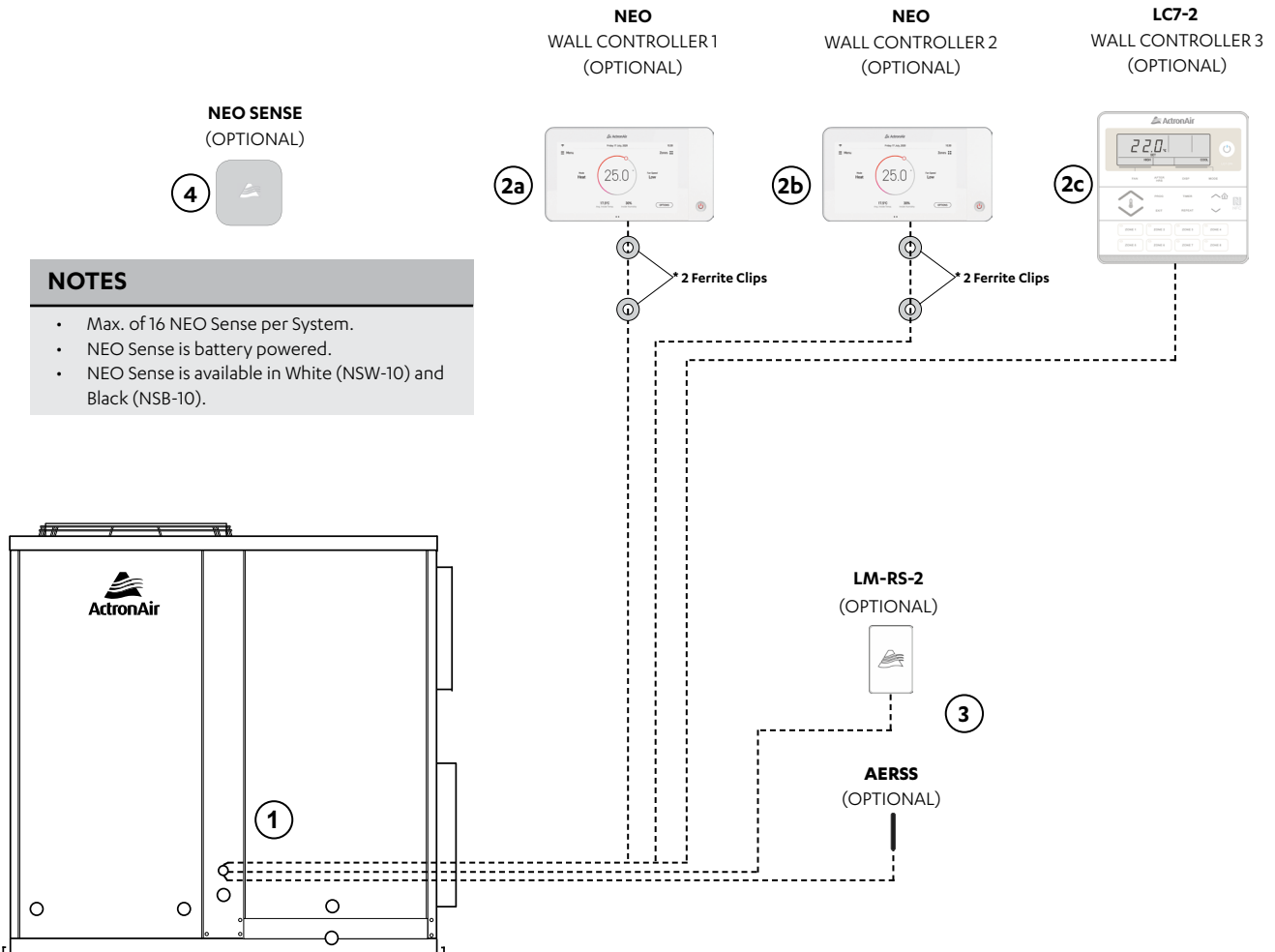

**NOTES**

- Max. of 16 NEO Sense per System.
- NEO Sense is battery powered.
- NEO Sense is available in White (NSW-10) and Black (NSB-10).

Item	Description	Maximum Cable Length
1 to 2a, 1 to 2b	Indoor PCB to Wall Control 1 and 2	90 m
1 to 2c	Indoor PCB to Wall Control 3	100 m
1 to 3	Indoor PCB to Remote Sensor	100 m

Description	Cable Type
LC7-2 and NEO Field Control Wiring	Cat5E UTP (AWG 24) Data Cable
Indoor to Remote Sensor	Cat5E UTP (AWG24) Data Cable

Wiring Configuration : Alternate

NOTES

- Diagram shown below is a general representation only. Refer to individual unit wiring diagram for complete wiring connection details.
- Long runs beside Mains cables or TV antenna cables should be avoided.
- Wiring configuration for LR7-1 and LC7-2 wall controller is the same.

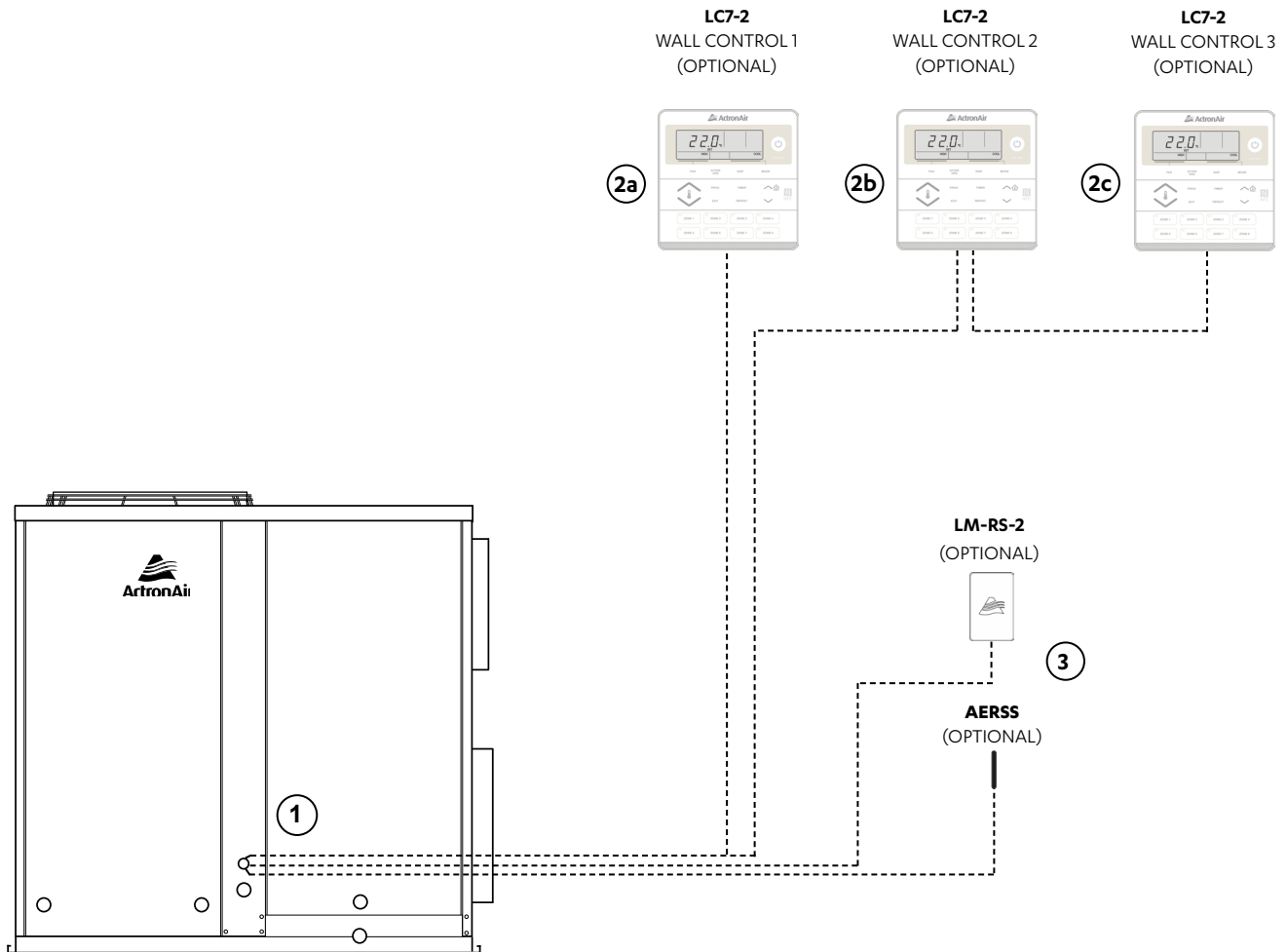

ITEM	DESCRIPTION	MAXIMUM CABLE LENGTH
1 to 2a	Indoor PCB to Wall Control 1 (optional)	100 m
1 to 2c	Indoor PCB to Wall Control 3 (optional)	75m total (Daisy Chain)*
1 to 3	Indoor PCB to Remote Sensor	100 m

\* Maximum Daisy Chain connection is up to 2 Wall Control.

DESCRIPTION	CABLE TYPE
LR7-1 / LC7-2 Field Control Wiring	Cat5E UTP (AWG 24) Data Cable
Indoor to Remote Sensor	Cat5E UTP (AWG24) Data Cable



## Unit Mounting and Location

1. The units must be installed in accordance with relevant authority regulations.
2. Install the unit on a level and strong foundation.
3. Install anti-vibration rubber or isolation mounts (installer to supply) under **all of the unit's feet** to help reduce noise and minimize vibration transfer through the foundation. Ensure that all anti-vibration rubbers are rated to provide stable support without impairing the unit's structural integrity.
4. Diameter or width of anti-vibration rubber's must be at least equal to the width of the actual feet to prevent deformation overtime.
5. Level the unit to ensure good condensate drainage away from the unit.
6. Ample service access areas and minimum space allowance for airflow must be provided.
7. Avoid installing the unit in such a place where there is danger of fire due to leakage of inflammable fluid.
8. Ensure that the spaces around the unit are free from any obstructions for optimum unit performance.

**Components Overview**

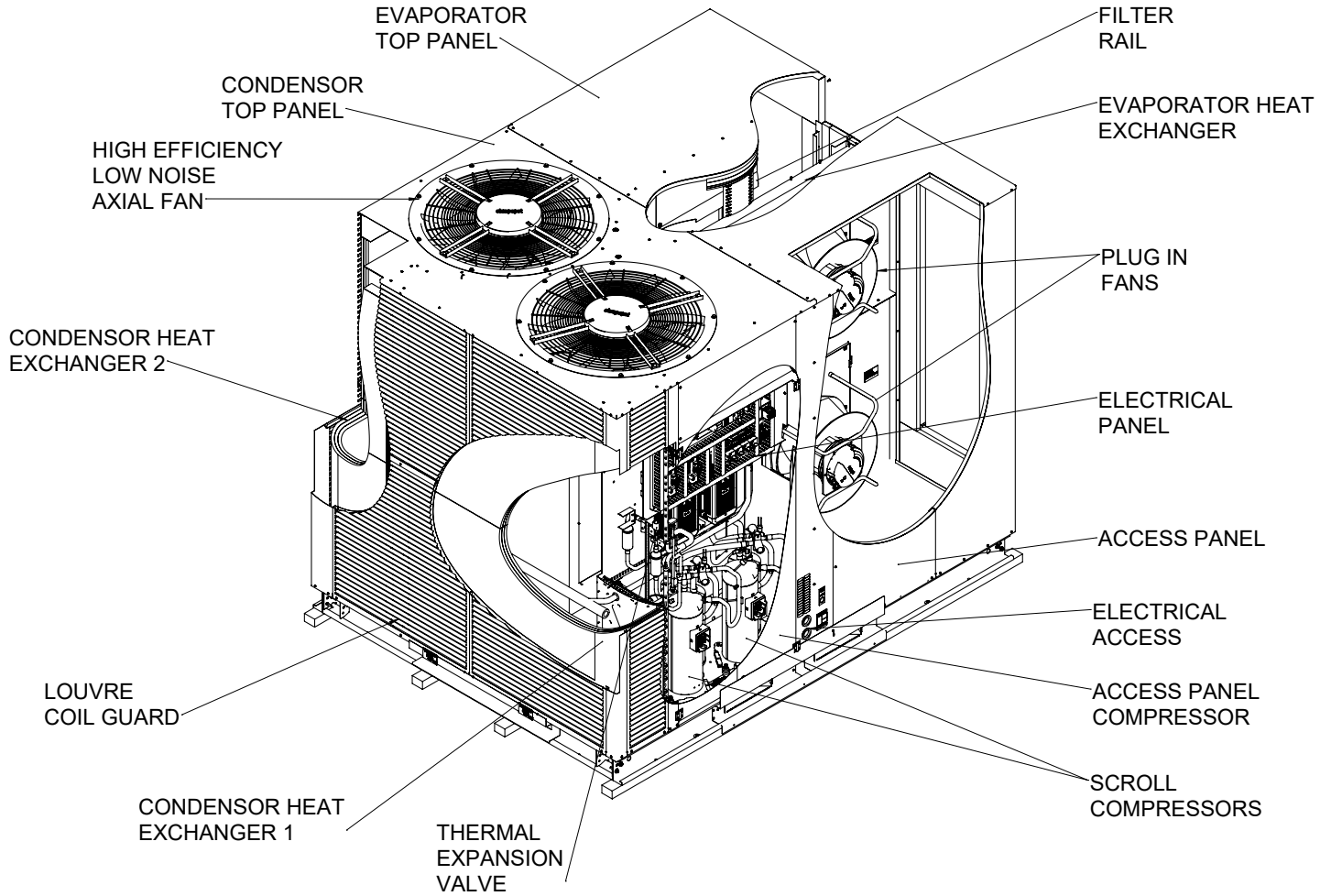

# Installation and Commissioning Guide

# VARIABLE CAPACITY

## Electrical Control Panel

PKV720T

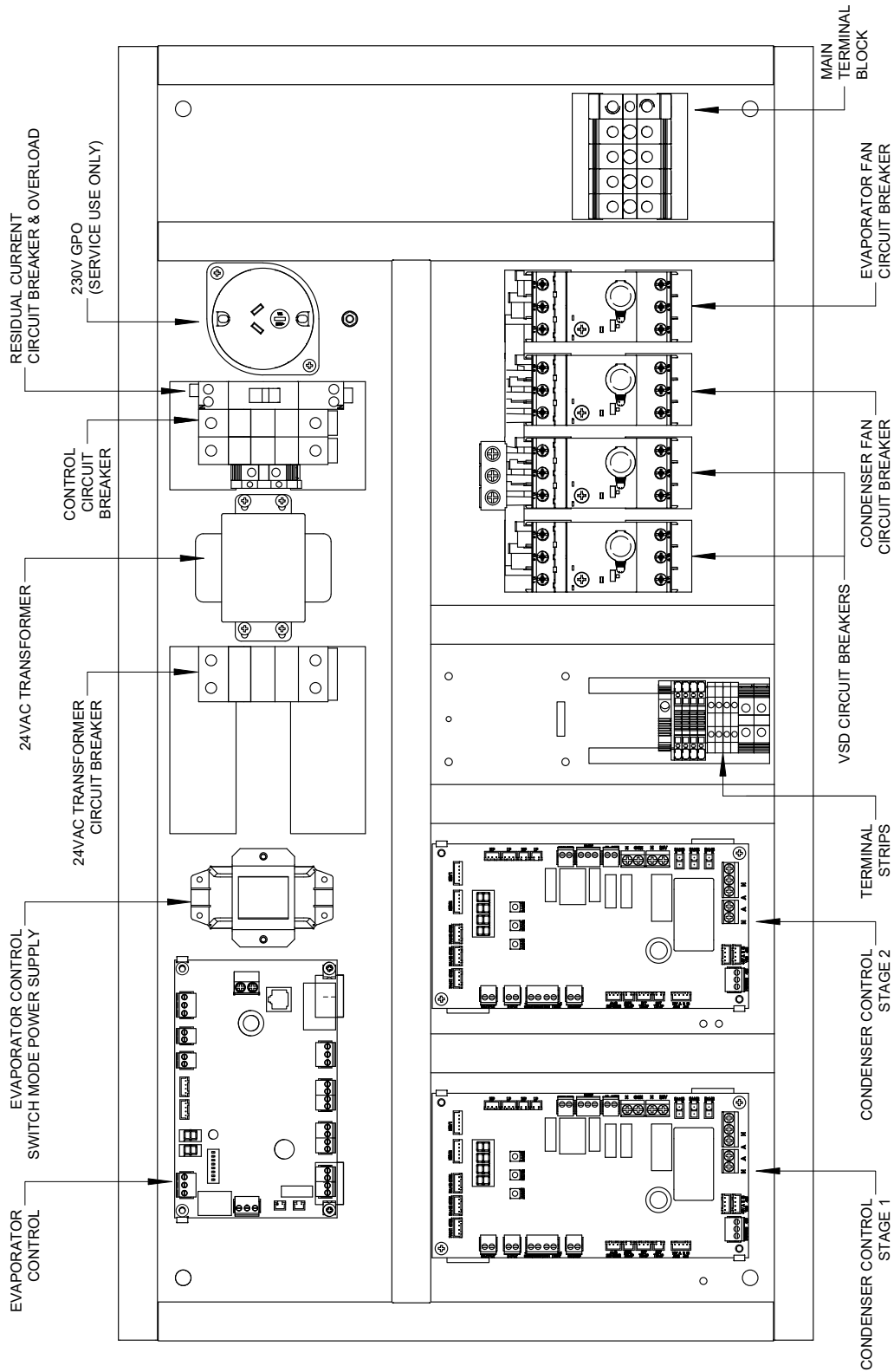

# Installation and Commissioning Guide

# VARIABLE CAPACITY

## PKV850T / PKV960T

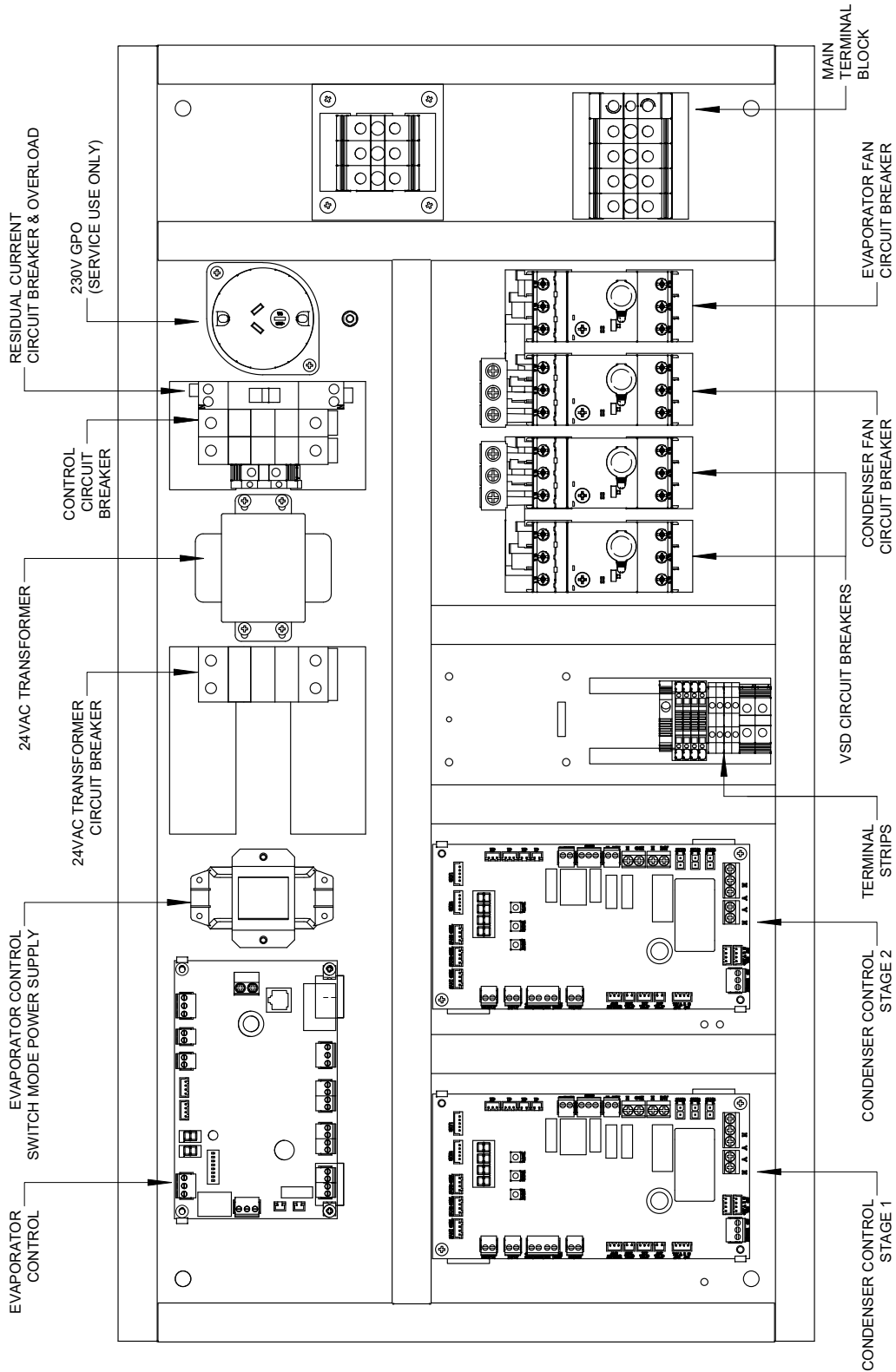

Group Control Option Electrical Board Layout

NOTE

Electrical board layout of 72kW shown below for illustration purposes only. Location for this option is same for the higher capacity.

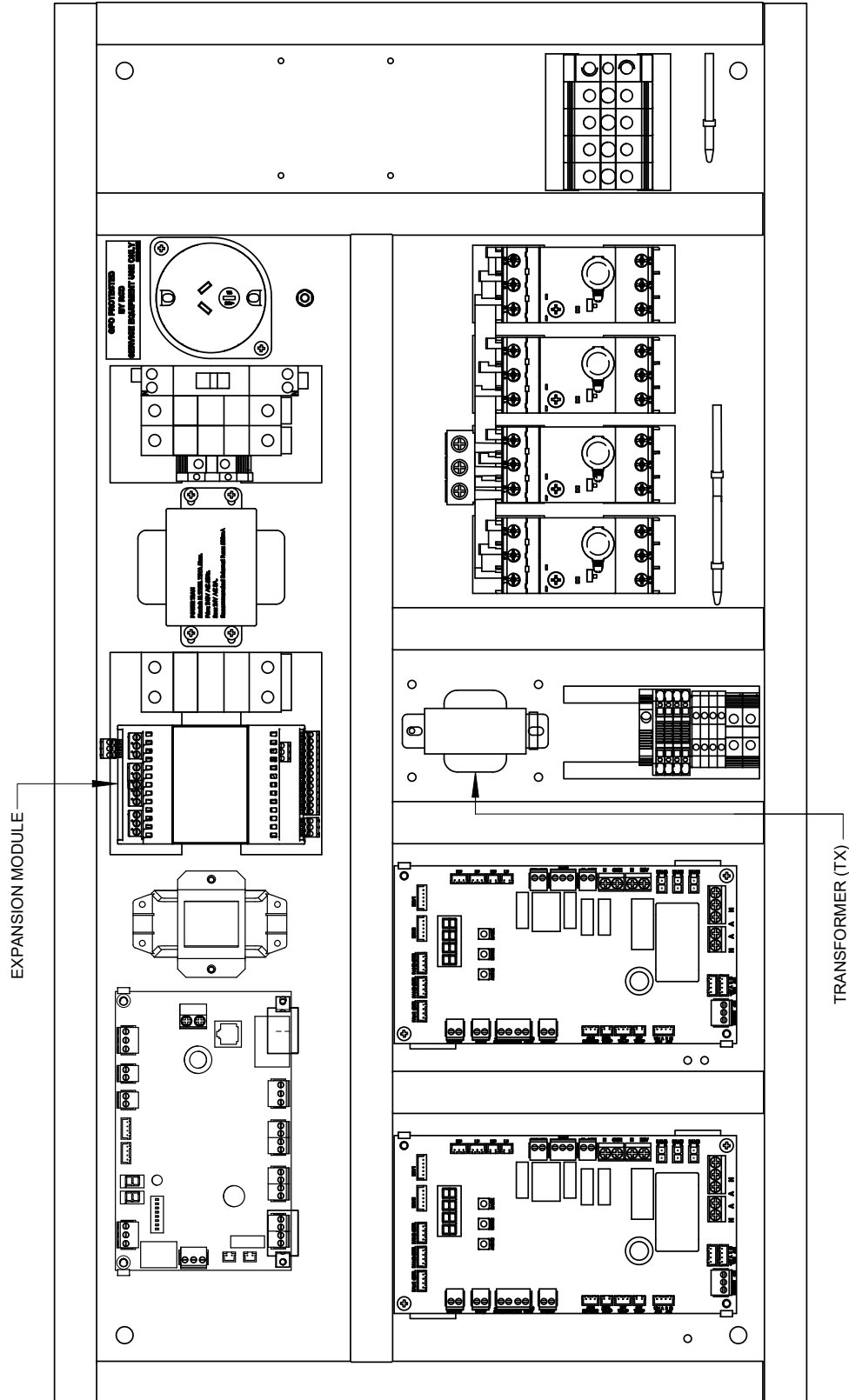

**BMS Option Electrical Board Layout**

**NOTE**

Electrical board layout of 72kW shown below for illustration purposes only. Location for this option is same for the higher capacity.

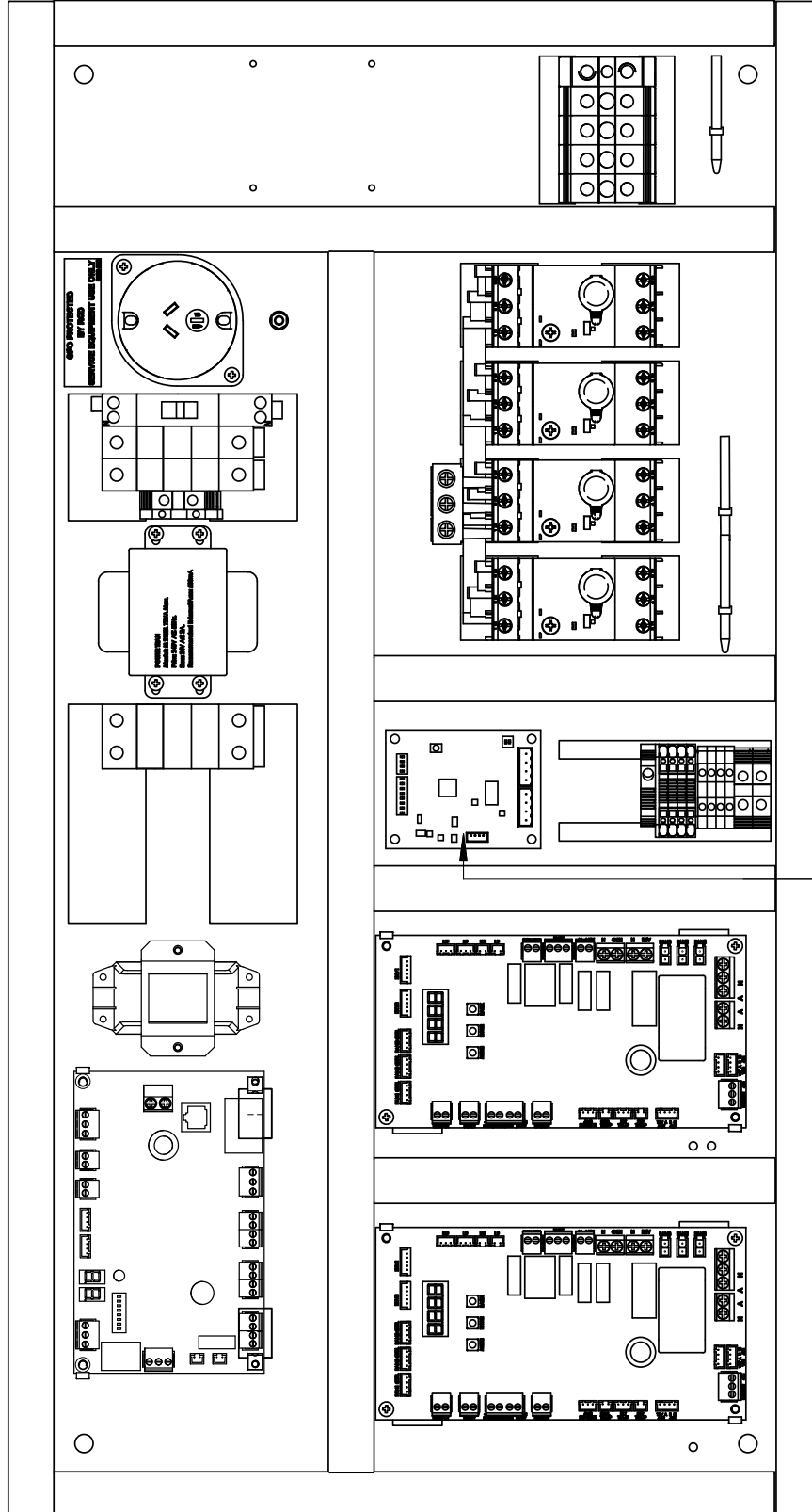

## Unit Dimensions, Clearances and Weights

### PKV720T

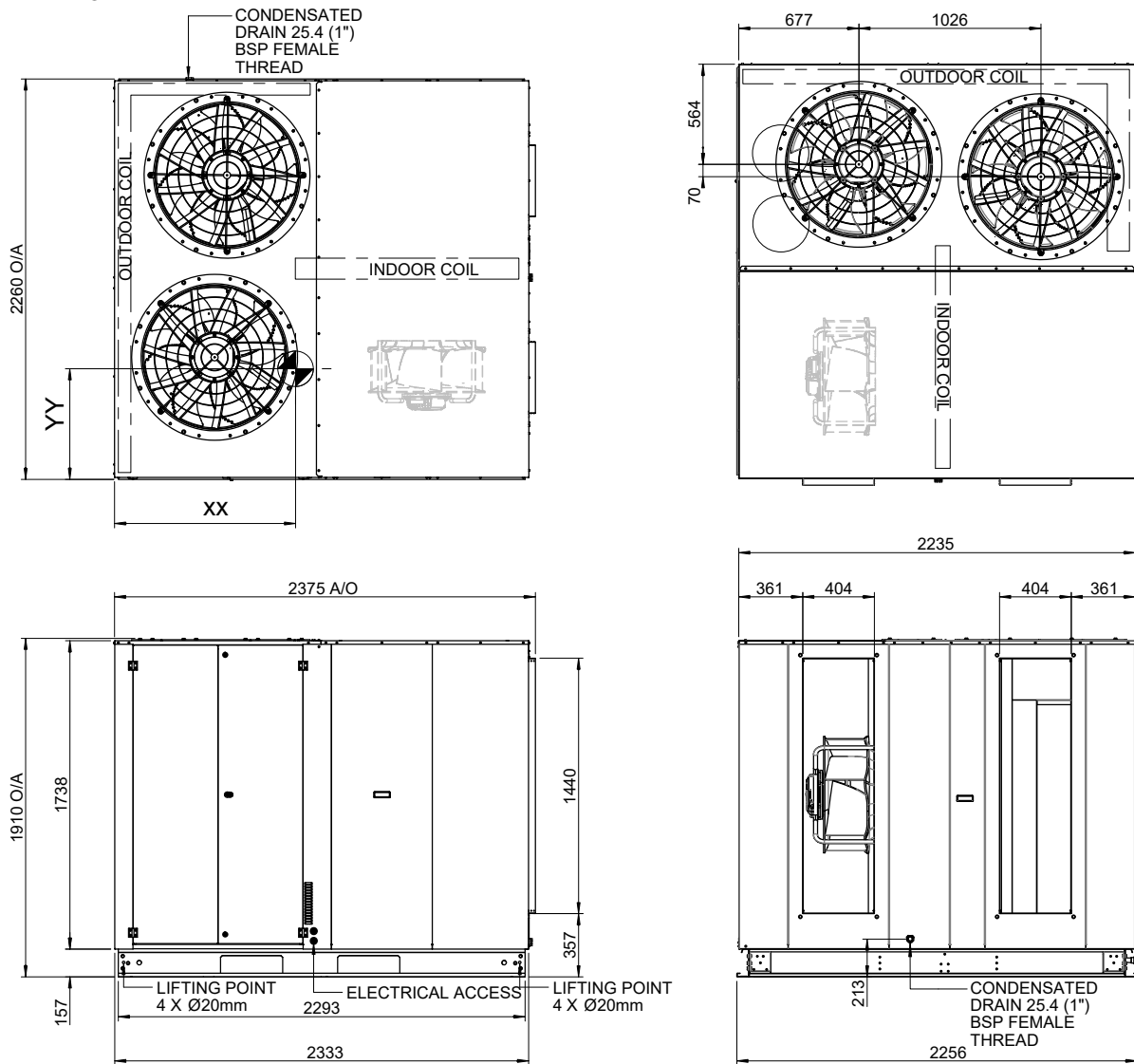

Unit Weight (kg)	Mounting Point Weights (kg)				Centre of Gravity Position	
	A	B	C	D	XX	YY
1096	347	285	123	341	1040	1136

#### NOTES:

- Do not scale drawing. All dimensions are in mm unless otherwise specified. Refer to corresponding unit dimensional drawing for mounting hole details.
- MTG C-C DIST = Mounting Centre to Centre Distance.
- Diagrams are left handing (LFFT).
- For right handing units, layout of above are mirrored.
  - The Supply and Return Air
  - Coil and Filter Access

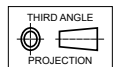

## PKV850T / PKV960T

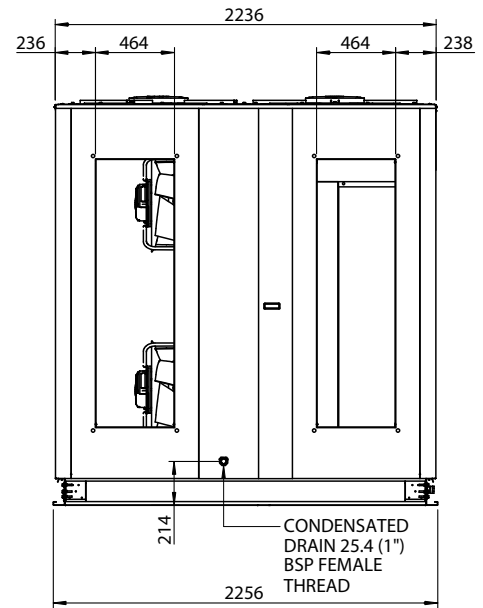
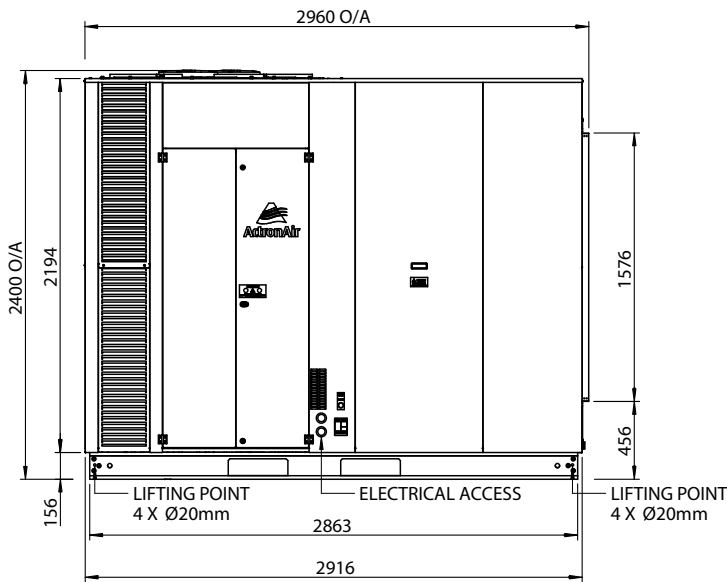
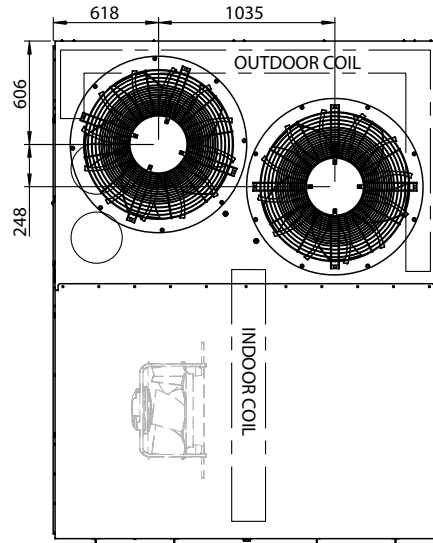
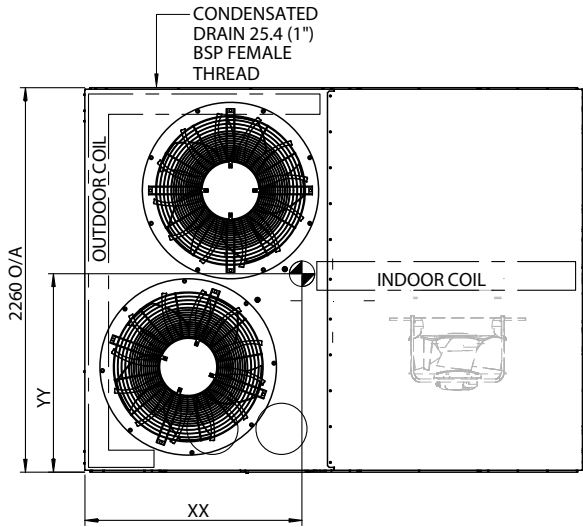

	Unit Weight (kg)	Corner Weights (kg)				Centre of Gravity Position	
		A	B	C	D	XX	YY
PKV850T	1371	405	355	182	429	1319	1143
PKV960T	1478	387	440	290	361	1271	1162

### NOTES:

- Do not scale drawing. All dimensions are in mm unless otherwise specified. Refer to corresponding unit dimensional drawing for mounting hole details.
- MTG C-C DIST = Mounting Centre to Centre Distance.
- Diagrams are left handing (LFFT).
- For right handing units, layout of above are mirrored.
  - The Supply and Return Air
  - Coil and Filter Access

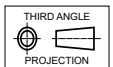



Service Clearances and Airflow Allowances

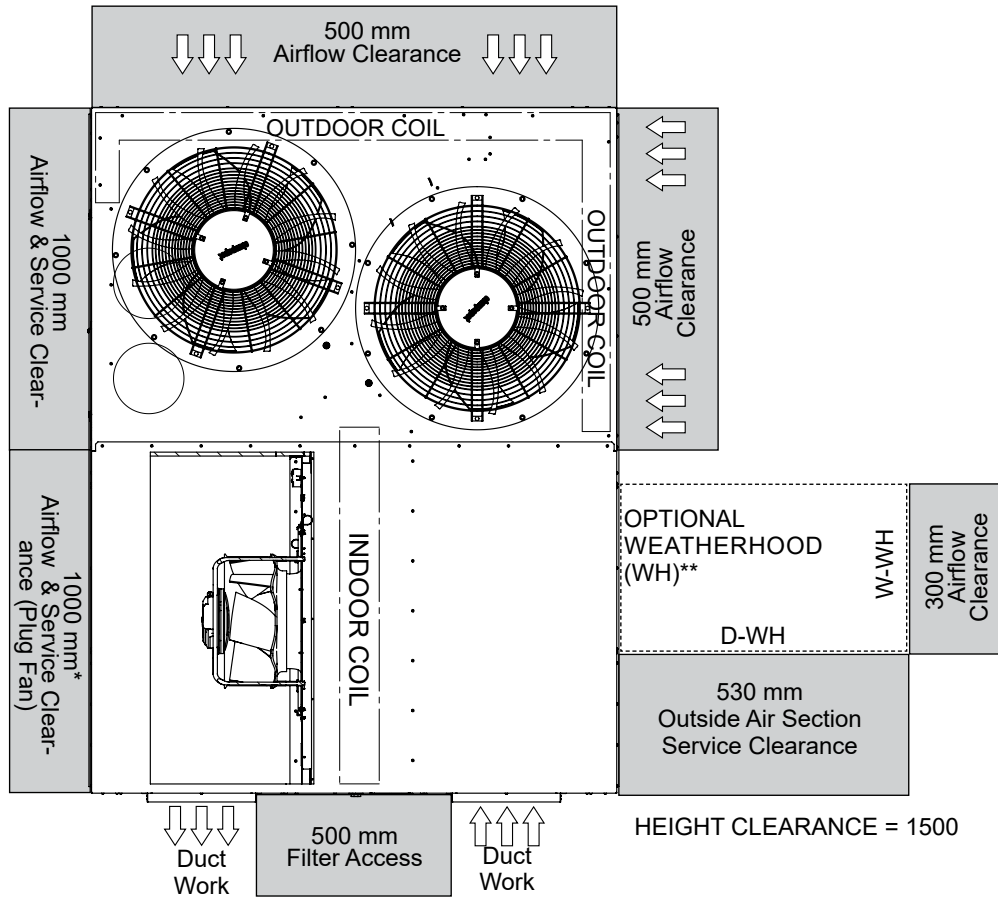

Model Numbers	Weatherhood Dimensions	
	D-WH	W-WH
PKV720T	1200	465
PKV850T	1100	660
PKV960T		

**NOTES:**

- \* For reverse handing, service clearance for plug fan and airflow clearance for hood will be reversed.
- \*\* If the optional hood is not installed, 500 mm clearance is required for service access.
- Service Access Areas and Spaces for Airflow Clearances are suggested minimum based on the condition that the spaces around the units are free from any obstructions and a walkaway passage of 1000 mm between the units or between the unit and the outside perimeter is available.
- Minimum service access areas and spaces for airflow clearances are responsibilities of the installer, ActronAir will not be held liable for any extra charges incurred due to lack of access and space for airflow.
- Under all circumstances, condenser air must not recirculate back onto condenser coil. Keep all clearance free of any obstruction.
- STACKING OF UNITS: Ensure that minimum airflow and clearances are met.
- Diagrams are left handing.

## Unit Base Dimensions

Down discharge/down return option shown below

### PKV720T

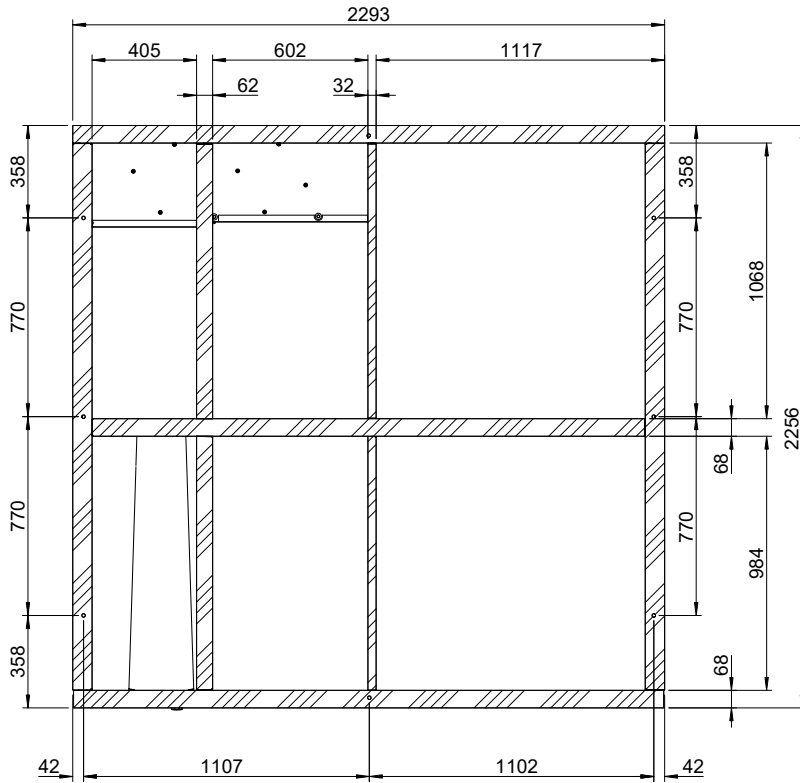

**NOTES:**  
Use M12 bolt for feet mounting.

### PKV850T / PKV960T

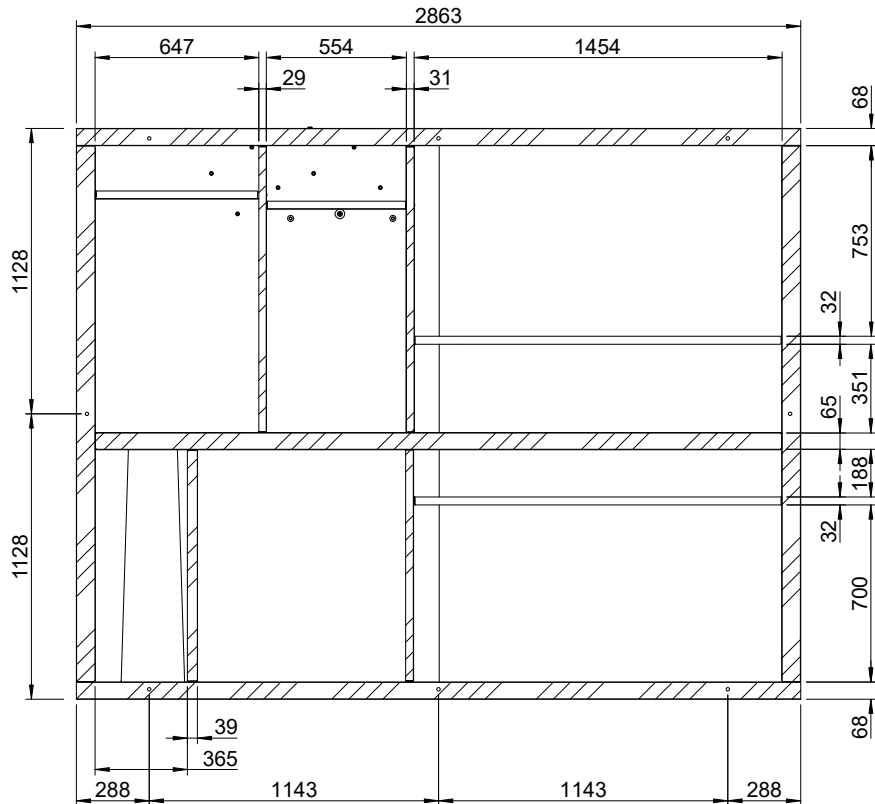

## Banking of Units

### End-To-End Configuration

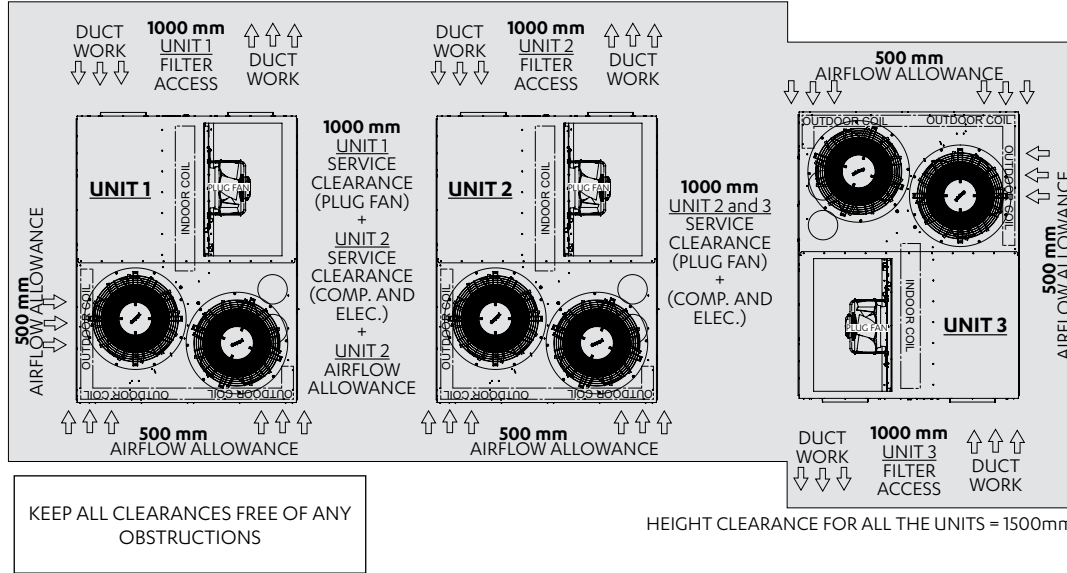

### Cluster Configuration

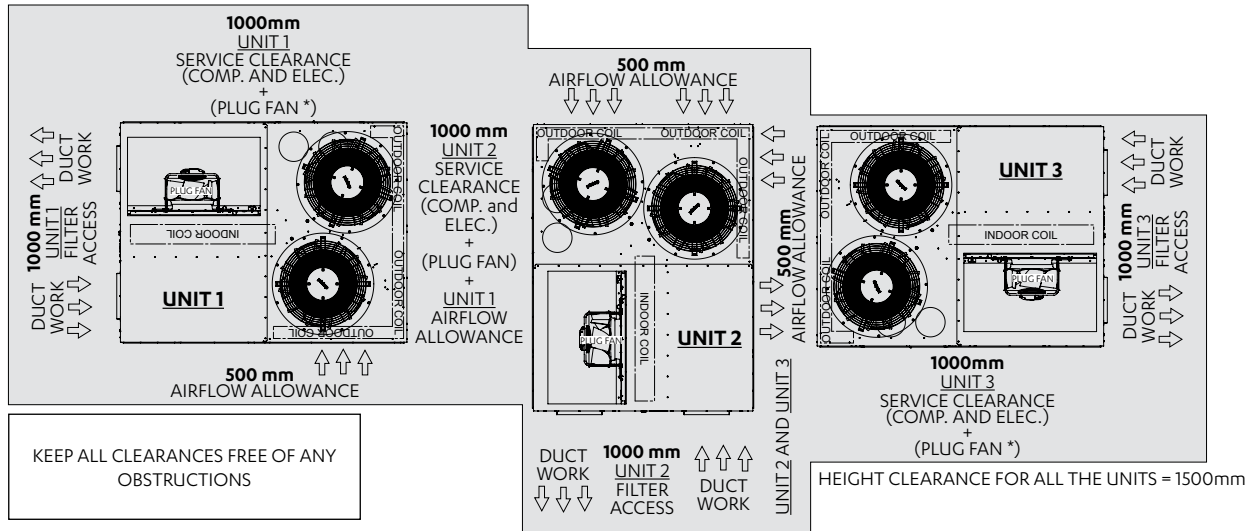

### NOTES

- The suggested Clearance and Airflow Allowances (given above) are the minimum and based on the condition that the spaces around the units are free from any obstructions and walkway passage of 1000mm between the units or between the unit and the outside perimeter is available.
- Minimum service access areas and spaces for airflow are responsibilities of the installer, ActronAir will not be held responsible for any extra charges incurred due to lack of access and space for airflow.
- Do not scale drawing.

Side-By-Side Configuration

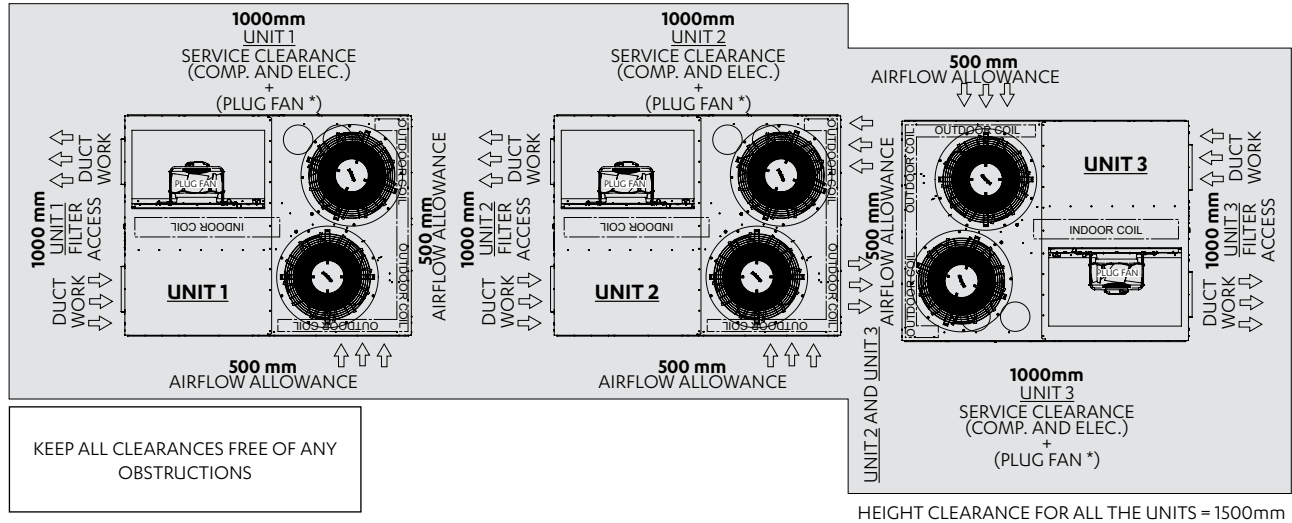

End-To-End Configuration (With Optional Hood) \*\*\*

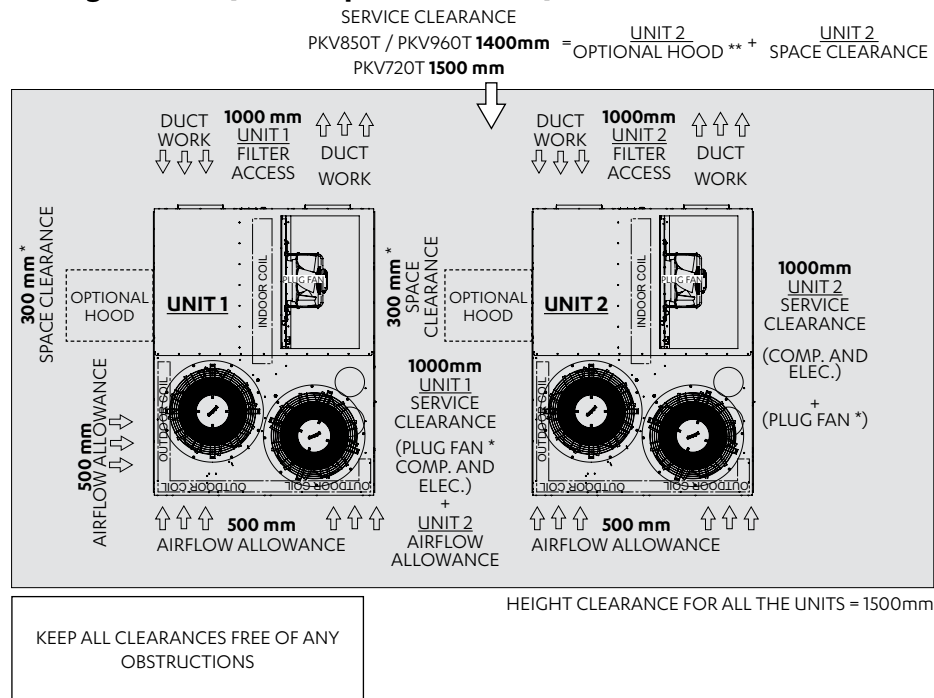

- \* For Reverse Handling, Plug Fan service clearance and Optional Hood space clearance will be reversed.
- \*\* Remove Optional Hood when service is required for the Plug Fan of the opposite unit.
- \*\*\* Configuration shown above is a sample only of the many possibilities of unit banking configurations with Optional Hood application. Provide a 300mm Space Clearance for the Optional Hood as shown.

**NOTES**

- The suggested Clearance and Airflow Allowances (given above) are the minimum and based on the condition that the spaces around the units are free from any obstructions and walkway passage of 1000mm between the units or between the unit and the outside perimeter is available.
- Minimum service access areas and spaces for airflow are responsibilities of the installer, ActronAir will not be held responsible for any extra charges incurred due to lack of access and space for airflow.
- Do not scale drawing.

## Unit Lifting Procedures

### NOTE

- WH&S regulations must be observed and will take precedent during lifting process.
- All drawings are for illustration purposes only. Actual unit may vary depending on the model.

### Crane Lifting Method

#### Note:

Crane lifting is recommended over fork lift method.  
Refer to catalogue for unit weight before selecting shackles.

#### Equipment Required for Crane Lifting:

1. spreader bar
2. 4 x shackles
3. 2 x nylon slings

#### Procedure:

1. Use 4 x Bow or Dee shackles to connect the lifting holes.
2. Slip nylon slings through all shackles.
3. Ensure slings are protected by rubber pads or similar if slings are draped across unit edges, corners, supply or return air spigots. This will prevent the unit from being damaged during lifting.
4. SPREADER BAR must be used when lifting the unit.
5. Remove all screws and washers that secure the unit to the timber pallet.
6. Remove pallet from the unit. (See pallet removal instructions below).

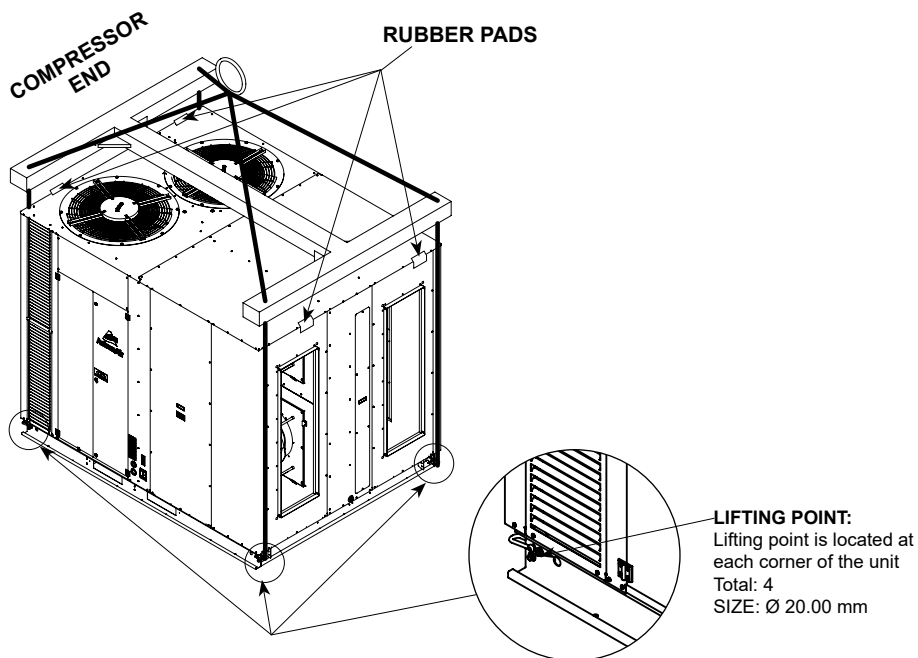

## Forklift Method

**Notes:** Ensure to remove screws and washers only when it is required to disassemble unit from the pallet.  
All dimensions are in mm. Use tine extensions as required.

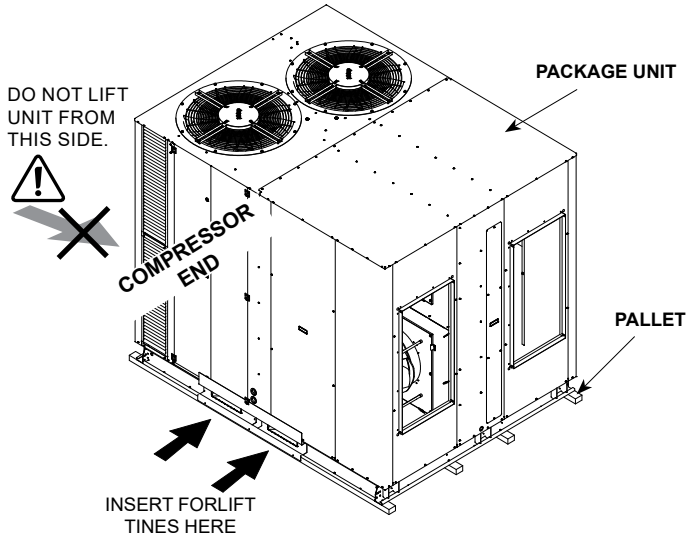

### Procedure:

1. To move the unit around with a forklift, insert the fork tines through the unit feet assembly, as shown.
2. Only fork the unit through compressor end.  
(see illustration for location of compressor end)

**Note:** Length of fork lift tines must pass the unit middle section, in order to safely carry the unit.

## UNIT FORK LIFTING HOLE DIMENSIONS

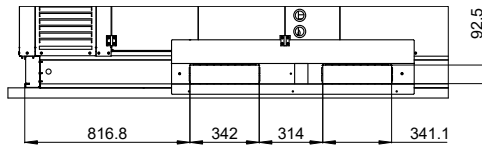

## PALLET REMOVAL INSTRUCTIONS

1. Remove Plate-Unit Protector from pallet and unit assembly.

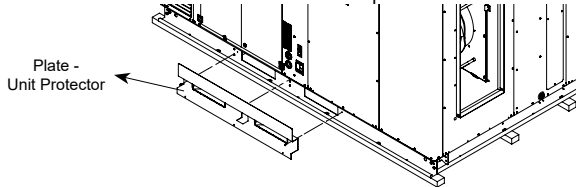

2. Remove Pallet from the unit as shown:  
(Lift unit to remove pallet by lifting method A or B)

### UNIT BASE SUB-ASSEMBLY

(Shown without the unit for illustration only)

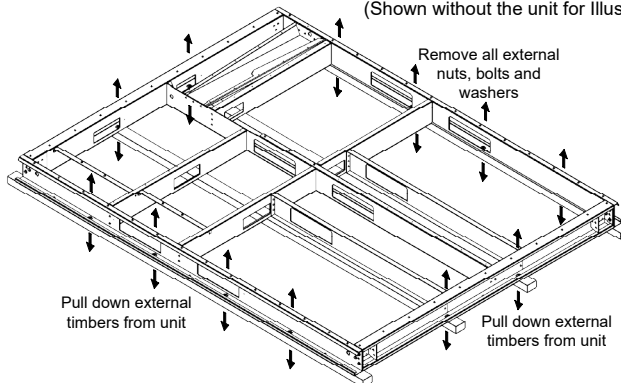

## Unit Preparation

1. Rotate the Hex Recess 90° using 8mm allen key.

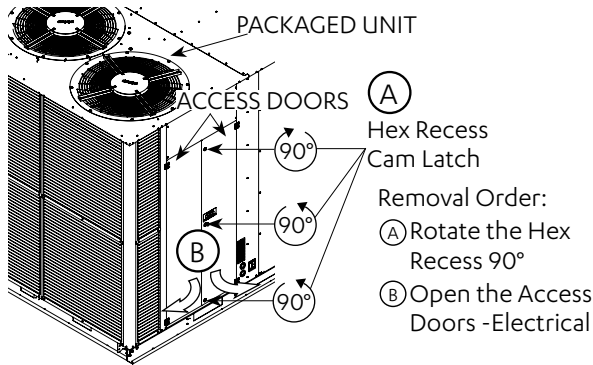

2. Open the Access Doors-Electrical as illustrated below.

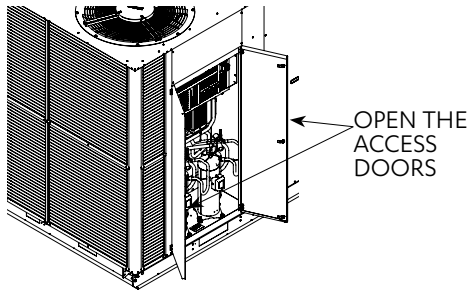

3. Remove the Shipping Blocks before installing Interconnection Field Pipes.

- a. Loosen the 4 x compressor feet bolts.

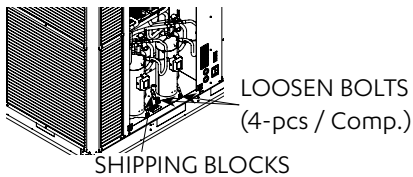

- b. Remove Shipping blocks as shown below.

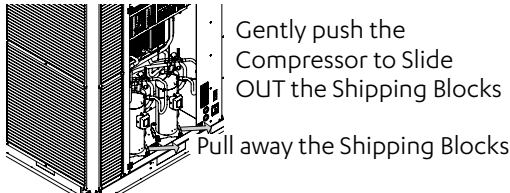

- c. Tighten back the Bolts - Firmly tighten the bolts to secure back the compressors onto the unit. Recommended torque is 13±1 Nm. It is critically important for the grommet not to be compressed. Check to make sure that there are no damage to the piping systems.

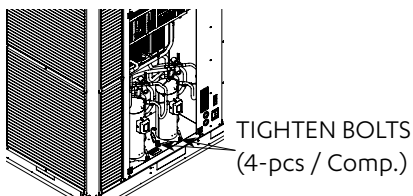

## Air Filter Installation

1. Remove Access Panel - Air Filter
  - Remove mounting screws (6 pieces).
  - Remove Access Panel - Air Filter as shown in the below illustration.

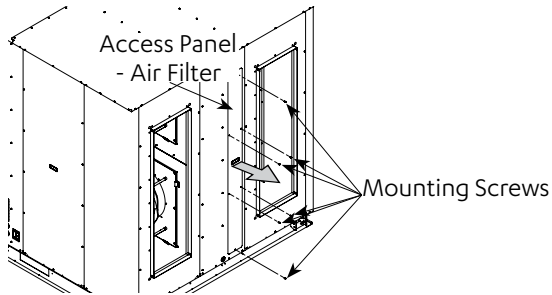

3. Replace Access Panel - Air Filter
  - Replace Access Panel - Air Filter as shown above.
  - Replace mounting screws, clean and tidy up the air conditioning unit.

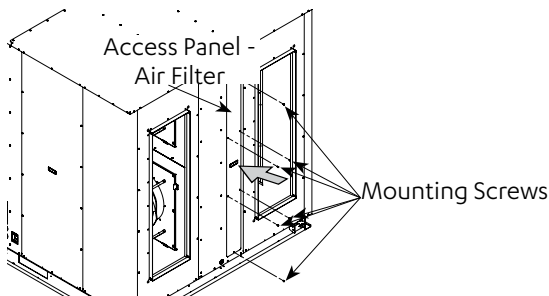

2. Install Air Filters

- Install Air Filters by sliding the filters one at a time in the provided Filter Rails.
- See notes and specifications below.

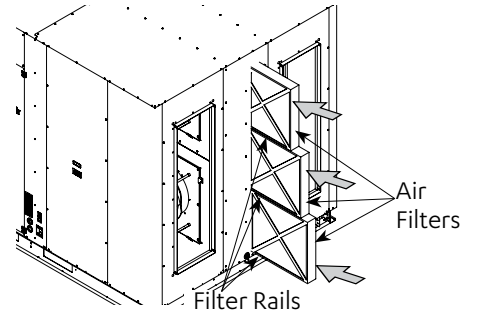

### NOTE

- Air Filters are not supplied with the unit.
- Adequate Air Filters must be supplied and fitted by the Installing Contractor.

### AIR FILTER SPECIFICATIONS

Models	Qty	Air Filter Sizes (H x W x T - Inch)
PKV700T	6	20 x 20 x 4
PKV850T		24 x 24 x 4
PKV960T		



## Electrical Installation

All electrical work must be carried out by a qualified technician. Make sure all wiring is in accordance with local wiring rules. Wiring connections should be made in accordance with the wiring diagram provided.



### DANGER

#### Live Electrical Supply !

- During installation of your air conditioning unit, it may be necessary to work in close proximity to live electricity. Only qualified technicians are allowed to perform these tasks.
- Follow all electrical safety precautions when exposed to live electrical components.
- Always make sure that all power supply, including remote controls, are disconnected before performing maintenance. Observe proper LOCK-OUT / TAG-OUT (LOTO) procedures to ensure that power cannot be inadvertently energised. Failure to disconnect power before maintenance procedure can result in serious injury or death.
- All electrical wiring must be in accordance with the relevant electrical authority rules and regulations.



### CAUTION

#### STATIC SENSITIVE ELECTRONIC DEVICES !

- DO NOT handle electronic devices unless you are wearing an Anti-Static Wrist Strap that is connected to a EARTH. Failure to protect the electronic devices from static electricity may cause unrepairable damage.
- Static damaged electronic devices are NOT COVERED for replacement under warranty.

### Wiring Diagram

The wiring diagrams specific for your air conditioning system are located on the inside of the electrical access panel.

Always refer all wiring installation, servicing and troubleshooting of this equipment to this diagram to ensure correct electrical connections are satisfied.

### Supply and Power Requirements Procedure

It is the installer's responsibility to provide power supply wiring to the sub-mains isolator. Wiring should conform to the current electrical authority regulations and all wiring connections to be as per electrical diagram provided with the unit.

- Confirm that the power supply available is compatible with the unit nameplate ratings. The supply power must be within +10% to -6% of the rated voltage as per AS60038.
- Protect electrical service from over current and short circuit conditions in accordance with the latest edition of the AS/ NZS 3000 "Australian / New Zealand Wiring Rules". Protection devices are to be sized accordingly as per to the electrical specifications of the unit.
- Complete the outdoor unit power supply wiring into the sub-mains isolator.
- Secure the power cords and control cables that enters in/exits out the unit. Use the cable ties provided in the electrical panels.
- Provide proper unit earthing in accordance with local and national wiring rules.
- Installer to connect an appropriate load break (AC3) isolator in sub mains wiring.

### Compressor Voltage Balance Requirement

Check the voltage at the mains supply terminals to determine if it is balanced. Voltage imbalance on three phase systems can cause motor overheating and premature failure. The maximum allowable imbalance is + 2.0% should voltage imbalance exceed this value, check unit wiring connections to locate and rectify faults or contact local supply authority.

## Electrical Connection

### NOTES

- To minimise noise interference, Data and Power cable clearance should be maintained as much as possible.
- All drawings are for illustration purposes only. Actual unit may vary depending on the model.
- All electrical components do not come with the unit, must be purchased separately.

### DETAILED WIRING DIAGRAM IS PROVIDED WITH THE UNIT.

Outdoor Unit: Located at the back of electrical/compressor access panel.  
 Indoor Unit: Located at the back of electrical box cover.

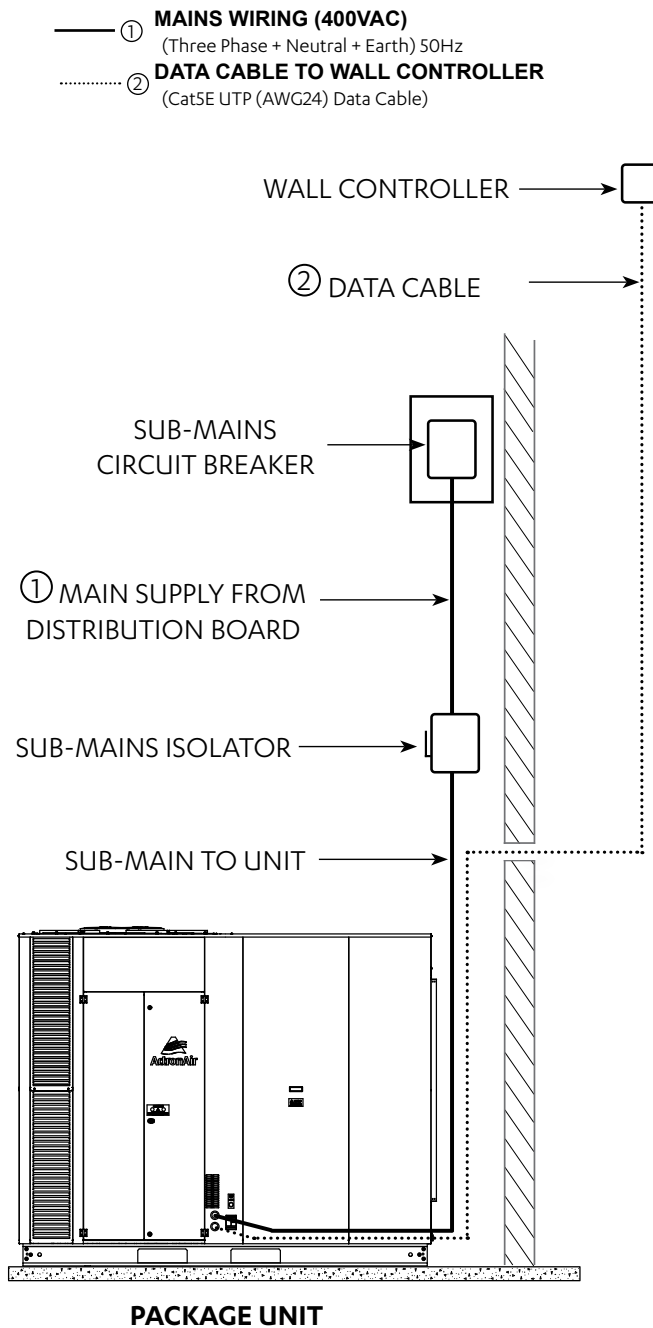

## Circuit Breaker Size Recommendation

Model	Circuit Breaker Size
	Amps
CRV720T / EVA720T	63
CRV850T / EVA850T	80
CRV960T / EVA960T	80
PKV720T	63
PKV850T	80
PKV960T	80

**Notes:**

Refer to latest edition of AS/ANZ 3000 or AS/ANZ 3008 Australian/New Zealand Wiring Rules to determine required cable size.

**Wiring Connections**

**LR7-1 and LC7-2 Wall Control Wiring Connections**

**WALL CONTROL WIRING**

- POWER: - BROWN / ORANGE
- 485 A: - BLUE
- 485 B: - BLUE-WHITE
- GND: - BROWN-WHITE / ORANGE-WHITE
- NOT USED: - GREEN / GREEN-WHITE

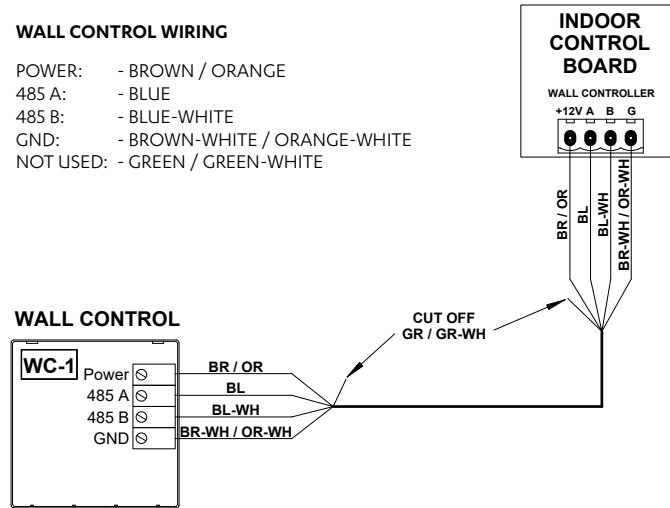

**NEO Wall Control Wiring Connections**

**NOTES**

Two FERRITE CLIPS, if supplied, should be installed 200 mm away and FERRITE 2 should be 400 mm away from the Wall Control.

**NEO Hard Wiring**

**WALL CONTROL WIRING**

- POWER: - BROWN / ORANGE
- 485 A: - BLUE
- 485 B: - BLUE-WHITE
- GND: - BROWN-WHITE / ORANGE-WHITE
- NOT USED: - GREEN / GREEN-WHITE

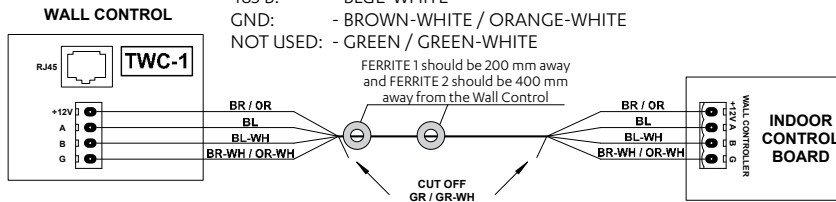

**NEO RJ45 Wiring**

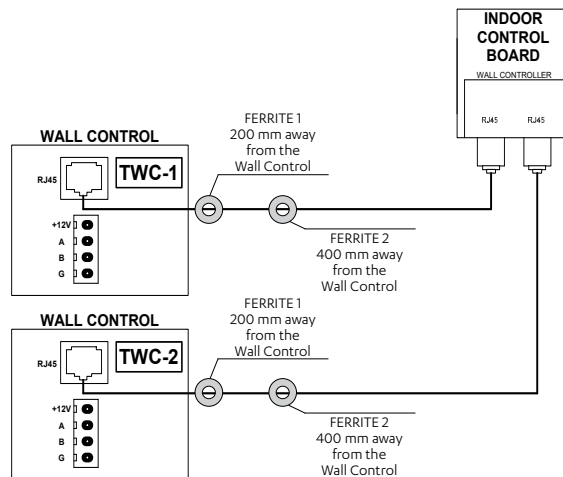

### LM-RS-2 Optional Sensor Wiring Connections

**REMOTE SENSOR WIRING**

- PAIR 1: - BLUE / BLUE-WHITE
- PAIR 2: - ORANGE / ORANGE-WHITE
- PAIR 3: - GREEN / GREEN-WHITE
- PAIR 4: - BROWN / BROWN-WHITE

**NOTE:**

- PAIR 1 AND 2 USED FOR ILLUSTRATION PURPOSES ONLY.
- CUT OFF AND TERMINATE ANY UNUSED PAIRS TO ENSURE NO WIRING IS LEFT EXPOSED.

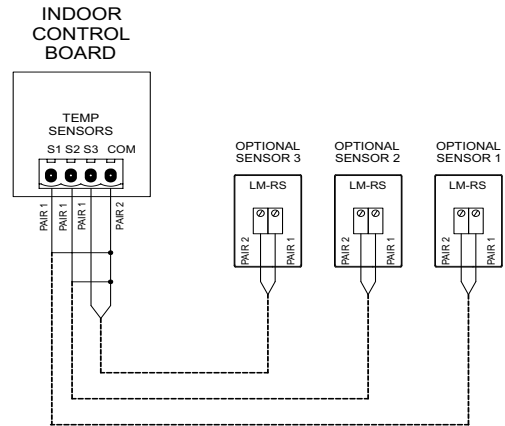

### AERSS Optional Duct Sensor Wiring Connections

**REMOTE SENSOR WIRING**

- PAIR 1: - BLUE / BLUE-WHITE
- PAIR 2: - ORANGE / ORANGE-WHITE
- PAIR 3: - GREEN / GREEN-WHITE
- PAIR 4: - BROWN / BROWN-WHITE

**NOTE:**

- PAIR 1 AND 2 USED FOR ILLUSTRATION PURPOSES ONLY.
- CUT OFF AND TERMINATE ANY UNUSED PAIRS TO ENSURE NO WIRING IS LEFT EXPOSED.

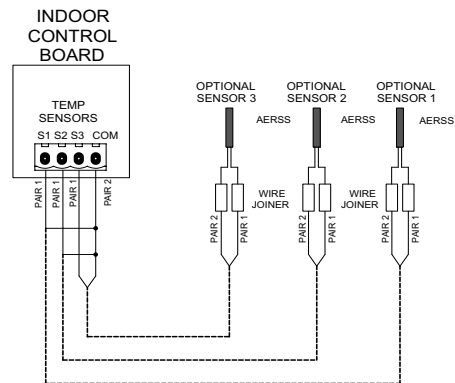

Wiring Diagram - PKV720T

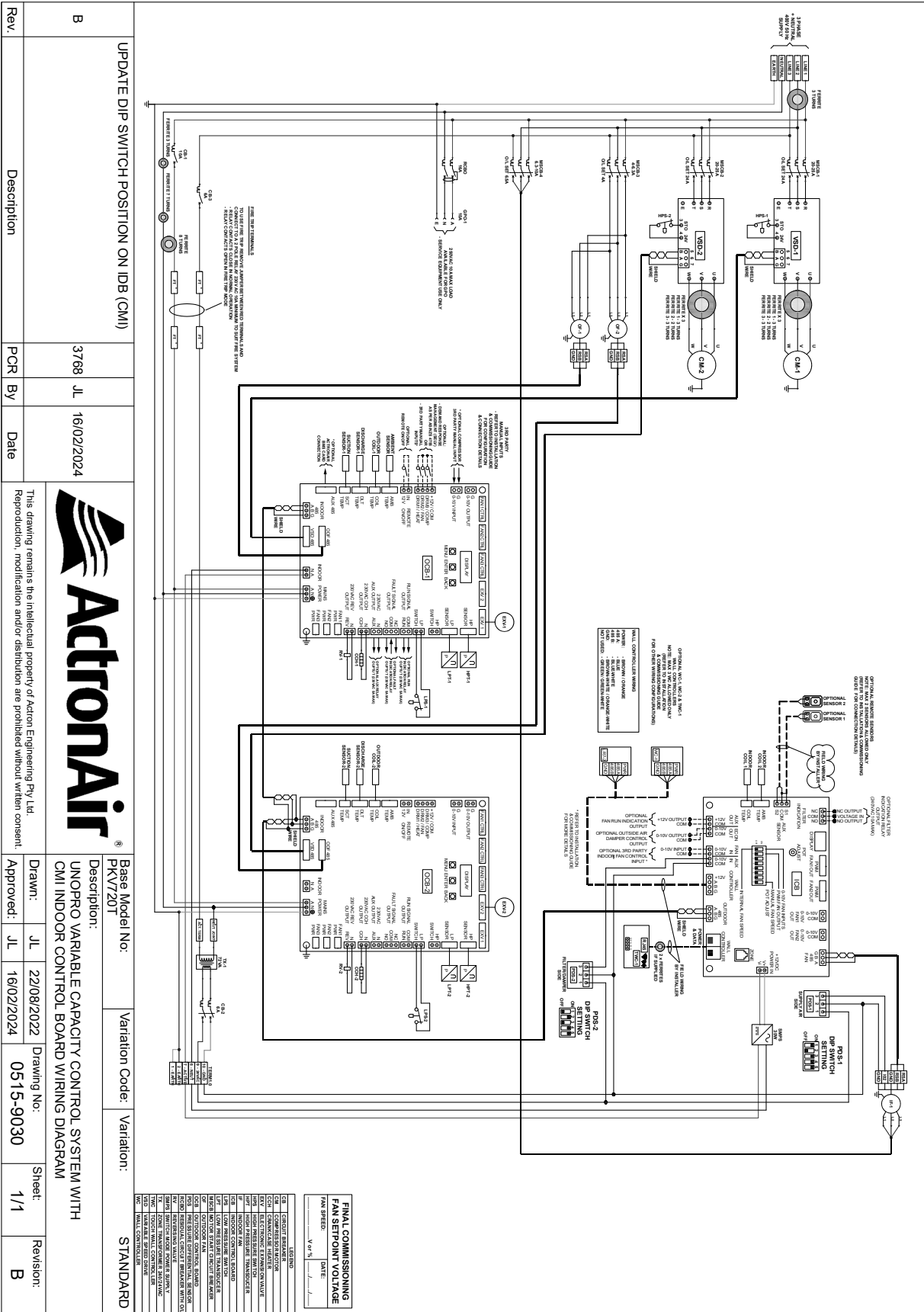

Rev.	Description	PCR	By	Date
B	UPDATE DIP SWITCH POSITION ON IDB (CM)	3768	JL	16/02/2024

**ActronAir**

This drawing remains the intellectual property of Actron Engineering Pty Ltd. Reproduction, modification and/or distribution is prohibited without written consent.

Base Model No.:	PKV720T	Variation Code:	STANDARD	
Drawn:	JL	22/08/2022	Drawing No.:	0515-9030
Approved:	JL	16/02/2024	Sheet	1/1
Revision:	B			







# Configuring and Commissioning Setup

## Menu and Navigation

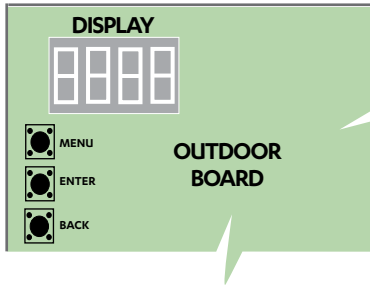

**MENU** Scroll through the items at the same menu level. Increment the value being set.

**ENTER** Go into the selected menu. Lock in selected value.

**BACK** Go back to the parent menu. Press and hold to go back to main menu.

\* Family and Capacity are the representative values only and may vary depend on the model purchased as seen below table. **Do not change setting.**

diS (Display)	Display system's status and settings		
SEr (Service)	Service use only		
SEt (Settings)	cnFg	F 06 = Family*	
		C072 = Capacity*	
		Cir.X (Circuit Selection)	Cir.1 = Circuit - 1 (default)
			Cir.2 = Circuit - 2
			Cir.3 = Circuit - 3
			Cir.4 = Circuit - 4
		Ct.X (Controller Selection)	Ct. 0 = 3rd Party
			Ct. 1 = Wall Control (default)
			Ct. 2 = Basic BMS
			Ct. 3 = Wall Control + Basic BMS
	CtrS	Ct. 4 = Advanced BMS	
		Ct. 0 = 3rd Party	
		Ct. 1 = Wall Control (default)	
		Ct. 2 = Basic BMS	
		Ct. 3 = Wall Control + Basic BMS	
	iduS	Ct. 4 = Advanced BMS	
		FP1 = IDU Fan Low PWM setting	
		FP2 = IDU Fan Med PWM setting	
		FP3 = IDU Fan High PWM setting	
		Fr1 = IDU Fan Low RPM setting	
		Fr2 = IDU Fan Med RPM setting	
		Fr3 = IDU Fan High RPM setting	
		FPd = IDU Fan Defrost PWM setting	
		FPc = IDU Reduced Airflow PWM setting	
		FiL = IDU Fan Filter Hours setting	
	Econ = IDU Econ 0-10V Output setting		
FnSE = Indoor Fan Setting			
run	no = Indoor Fan and Compressor (default)		
	YES = Compressor only		
odFS	odHS = OD Fan External Static		
qS	CCS = Cooling compressor speed		
	HCS = Heating compressor speed		
	CCT = Cooling mode critical temp. condition.		
	HCT = Heating mode critical temp. condition.		

Continuation of SEt (Settings)

SEt (Settings)	
ECn	On = Group Control enabled
	Off = Group Control disabled (default)
ECoE	oAdC = Outside air damper enable
	oAdo = Outside air damper On Off
	ECEo = Economiser control enable
	EHCE = Humidity control enable
	EHCo = Humidity control mode
	EHCS = Humidity sensor source
ECoS	CCE = CO2 control enable
	Etd = Economiser temperature difference
	EOlt = Economiser outside min temp
	EOht = Economiser outside max temp
	EOld = Economiser outside min damper
	EOhd = Economiser outside max damper
	EOHH = Economiser outside max humidity
	EOHn = Economiser outside max moisture
	EodP = Economiser outside max dew point
	EOHE = Economiser outside max enthalpy
	EEd = Economiser enthalpy delta
	ELPL = Economiser CO2 p1
	EHPL = Economiser CO2 p2
	ELdP = Economiser CO2 damper p1
EHdP = Economiser CO2 damper p2	
dSH	dSHE = De-superheater enable
	dHds = De-superheater enable-heating only
	dCt = De-superheater critical temp.
ECS	on = Compressor Staggering Enabled (default)
	oFF = Compressor Staggering Disabled
AFC	(Indoor Fan K-Factor)
	425 = 96kW
	425 = 85kW
HtSt	545 = 72kW
	on = Hot Start enabled (for BMS only)
	oFF = Hot Start disabled (default)

Family and Capacity Table							
Model		CRV720T	CRV850T	CRV960T	PKV720T	PKV850T	PKV960T
Family	Type	Capacity (kW)					
F 06	Split	C072	C085	C096	-	-	-
F 07	Package	-	-	-	C072	C085	C096

### Configuring Compressor and Capacity(cnFg)

Configure the compressor type and capacity. The unit is factory configured. **Do not change this setting.**

### Configuring Control Source (CtrS)

This commissioning is applicable for BMS and third party control.

Configurable settings are as follows:

#### Third Party Control

The unit can be controlled by non-ActronAir wall control. To do this, **CtrS** on the Outdoor Board has to be set to **Ct. 0**. For connection details, see the wiring diagram supplied with the outdoor unit.

#### Wall Control

ActronAir offers NEO, LR7-1 and LC7-2, wall controls that can control the available features and maximise the function and operation of the air conditioner. To do this, **CtrS** on the Outdoor Board must be set to **Ct. 1**.

#### Basic BMS

The unit can be connected to a network through a BMS card (ICUNO-MOD). This allows the unit to be operated in the same way the as the NEO, LR7-1 and LC7-2 does. To do this, **CtrS** on the Outdoor Board must be set to **Ct. 2**.

#### Wall Control + Basic BMS

The unit can be connected to a network (Basic BMS) and at the same time be controlled using the NEO, LR7-1 or LC7-2 controller. Priority will be given to the most recent command. To do this, **CtrS** on the Outdoor Board must be set to **Ct. 3**.

#### Advanced BMS

The unit can be connected for system that requires customised functions not included in the existing software or logic in the Outdoor Board but still retaining the safety logic. To do this, **CtrS** on the Outdoor Board must be set to **Ct. 4**.

## Optional BMS Control

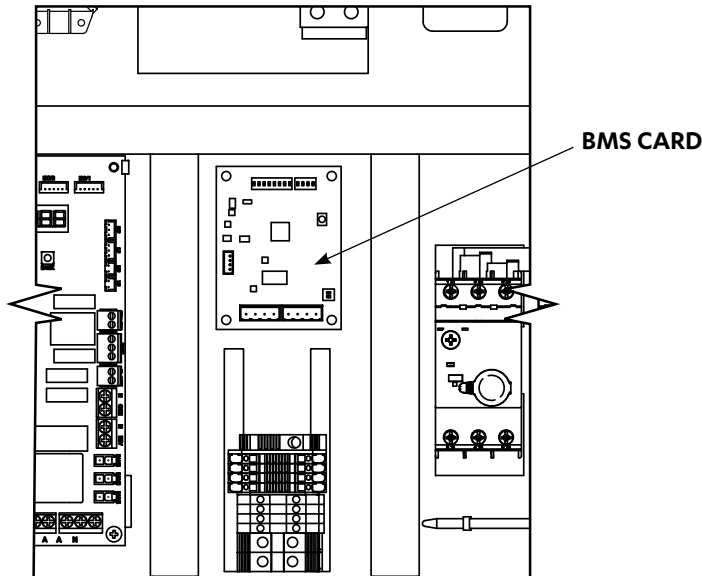

**NOTE**

- Refer to ICUNO-Mod Installation and Commissioning Guide for more information.
- BMS card will be connected to ODU board Stage 1

BMS PART NUMBERS		
BMS Connection Type	Kit Part Number *	Order Form
MODBUS 485	ICUNO-MOD	Not required

\* To be purchased separately.

**⚡ DANGER**

**Hazardous Voltage !**

- Always make sure that all power supply, including remote controls, are disconnected before performing maintenance. Observe proper LOCK-OUT / TAG-OUT (LOTO) procedures to ensure that power cannot be inadvertently energised. Failure to disconnect power before maintenance procedures can result in serious injury or death.
- Follow all electrical safety precautions when exposed to live electrical components.
- Only qualified technicians are allowed to work on electrical circuits.
- All electrical wiring must be in accordance with the relevant electrical authority rules and regulations.

**⚡ CAUTION**

**STATIC SENSITIVE ELECTRONIC DEVICES !**

- DO NOT handle electronic devices unless you are wearing an Anti-Static Wrist Strap that is connected to a GOOD EARTH. Failure to protect the electronic devices from static electricity may cause unreparable damage.
- Static damaged electronic devices are NOT COVERED for replacement under warranty.

## Accessing Service and Technical via NEO

Special options are available via Advance Option menu. This must be accessed through Service and Technical section. Follow the steps as shown below:

1. To access the Menu, touch on the hamburger icon (☰) on the NEO Controller.

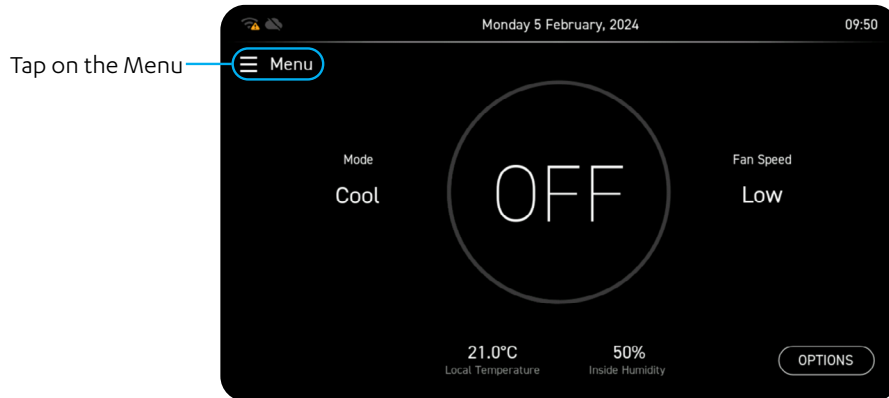

2. On the Main Menu, Select the **Service & Technical** Section.

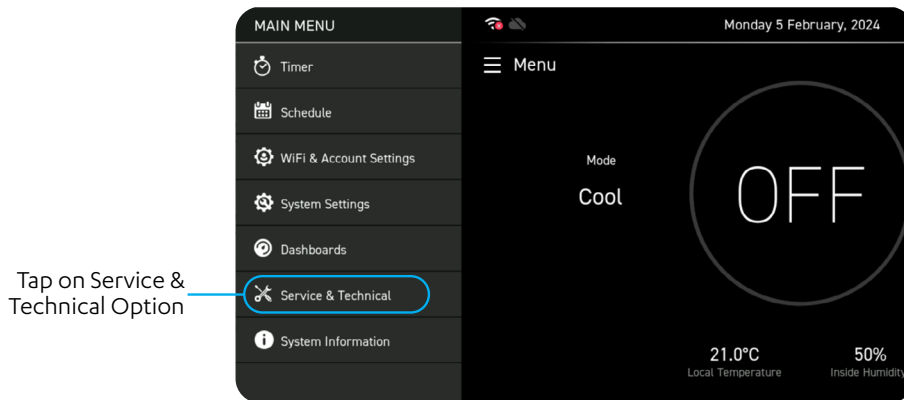

3. An Access Code will be asked. Provide Access Code - **7378**

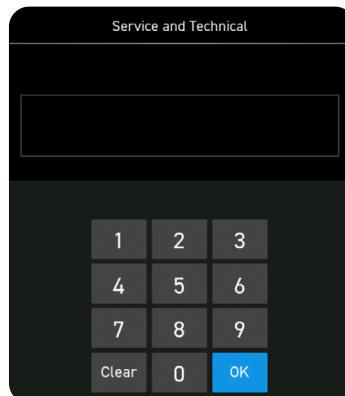

4. The **Service & Technical** Section screen is as below:

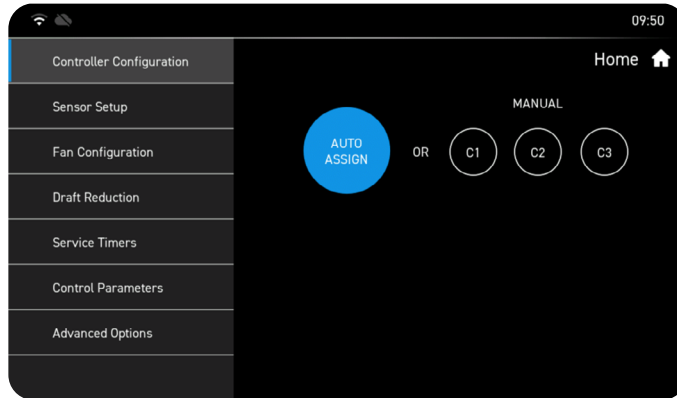

## After Hours Logic with Timeclock (Scheduler)

After Hours is the duration (in minutes) in which the unit will turn ON when the After Hours is set. By default, this is set to 0 min. The Minimum Settable Value is 1 min and the Maximum Settable Value is 120 mins. Setting this will be accessible via Service & Technical menu.

Set up the After Hours via the Control Interface as follow:

1. In the **Service and Technical** Section, select the **Advanced Options**.

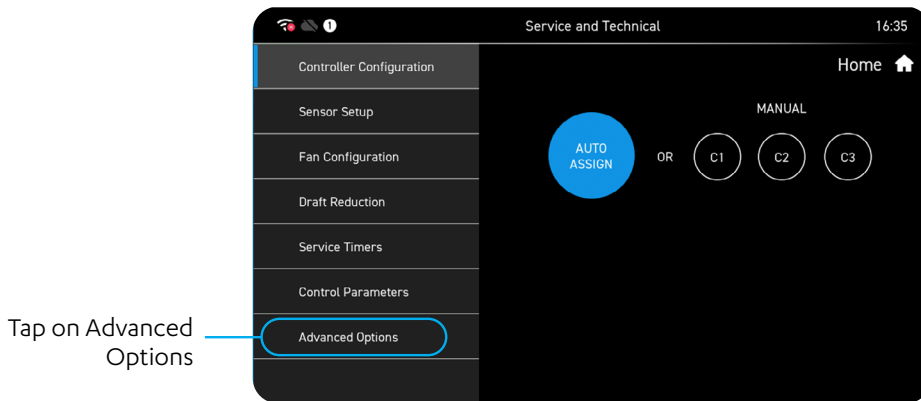

2. In the Advanced Options, select **Enable Commercial Application Mode** by tapping on the check box.

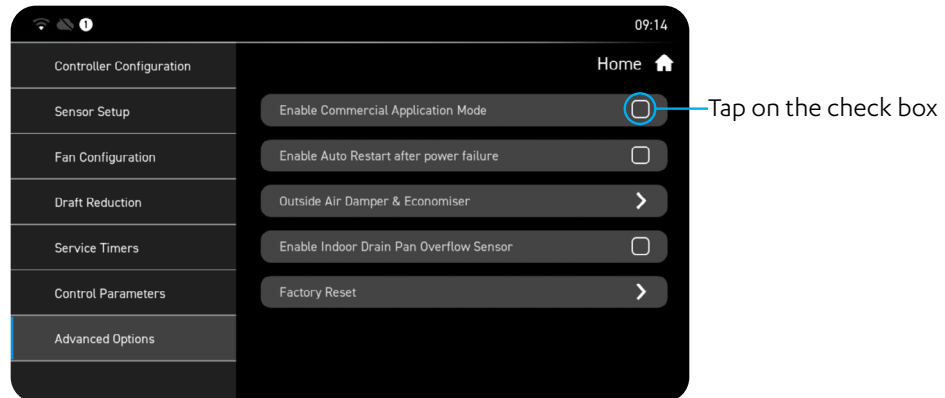

3. Touch on the **Options** tab to get to the next slide.

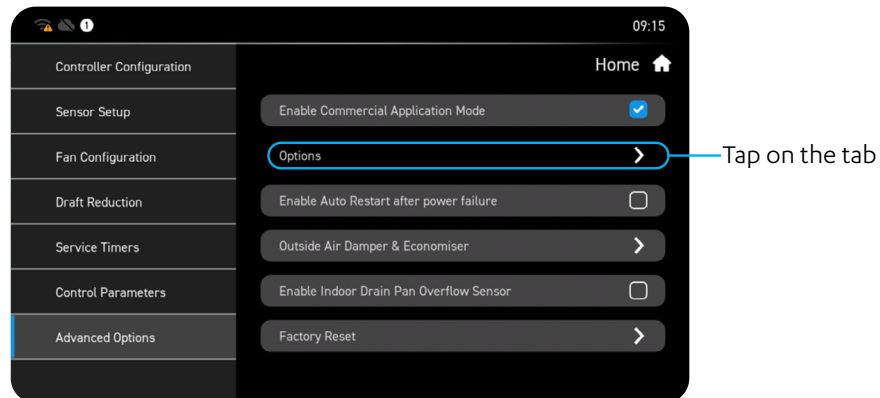

4. Activate the **After Hours Mode** by tapping on the check box.

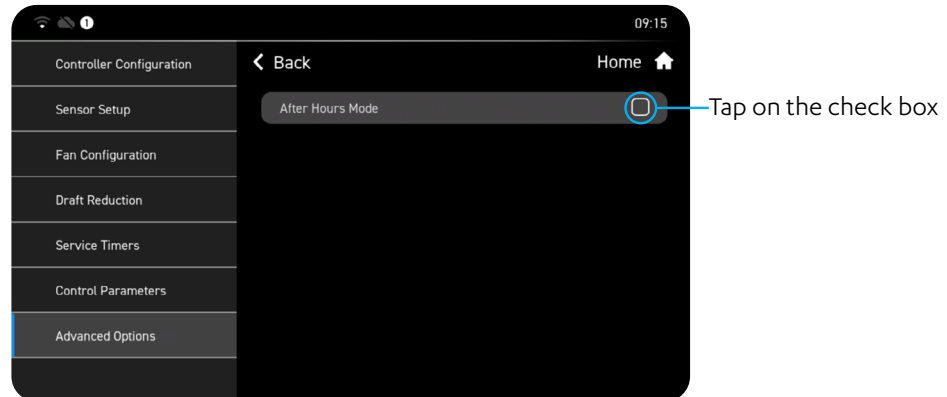

5. Make necessary changes as the settings will be automatically saved. Touch on the **Home** button on the top right corner to go back to the **Home** screen.

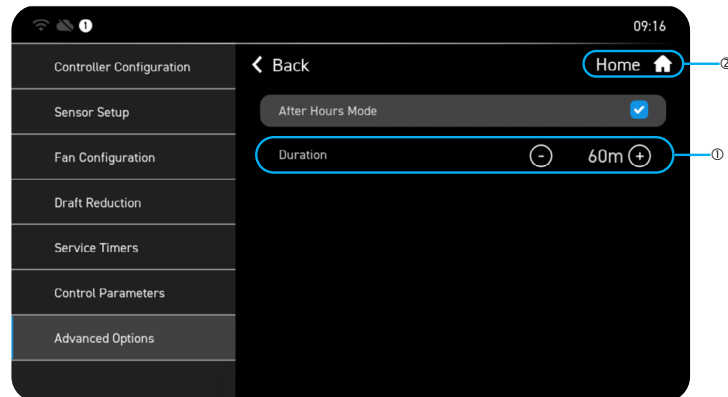

6. **Home** screen.

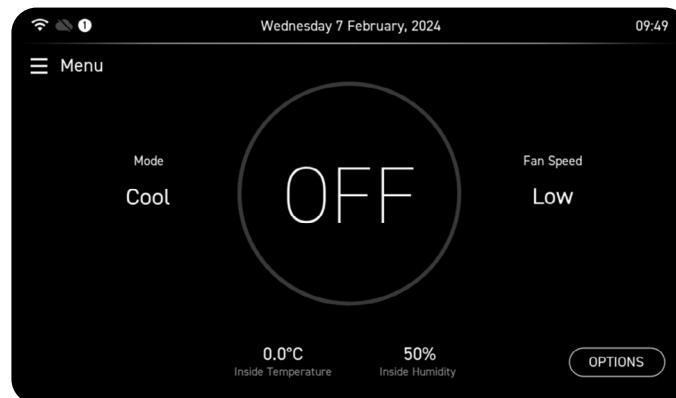

7. To view the new setting of the **After Hours Mode**, touch the **Menu** button on the **Home** screen.

Tap on the Menu



8. Select the **After Hours** and the new settings will appear.

Tap on After Hours

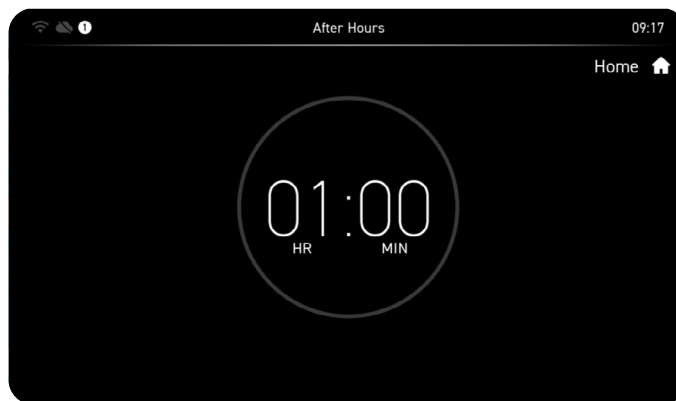
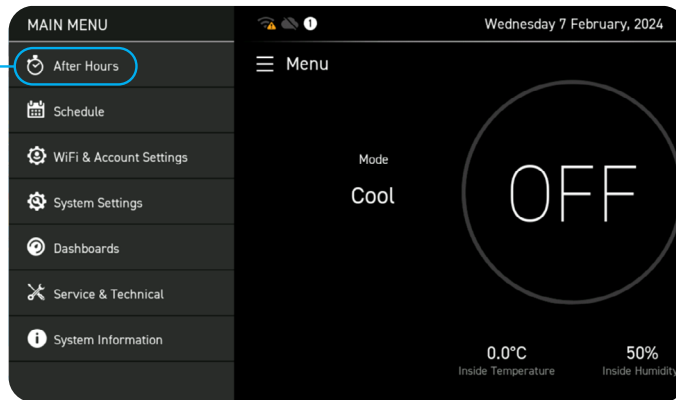



## Filter Alarm Configuration

This gives the user an option to Enable and set the Air Filter Alarm . The setting is accessible via Service & Technical menu.

### Filter Alarm Configuration

The filter timer can be set via the Control Interface as follow:

1. In the **Service & Technical** Section, select the **Service Timers**.

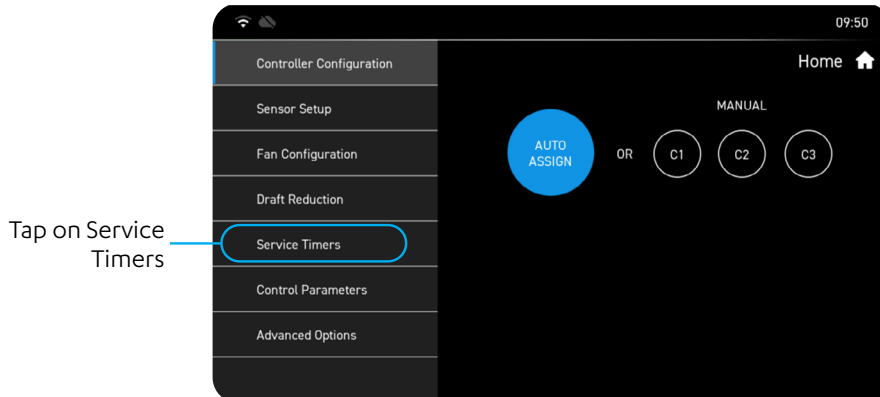

2. In the Service Timers, select **Fan Filter Alarm Configuration** by tapping on the tab

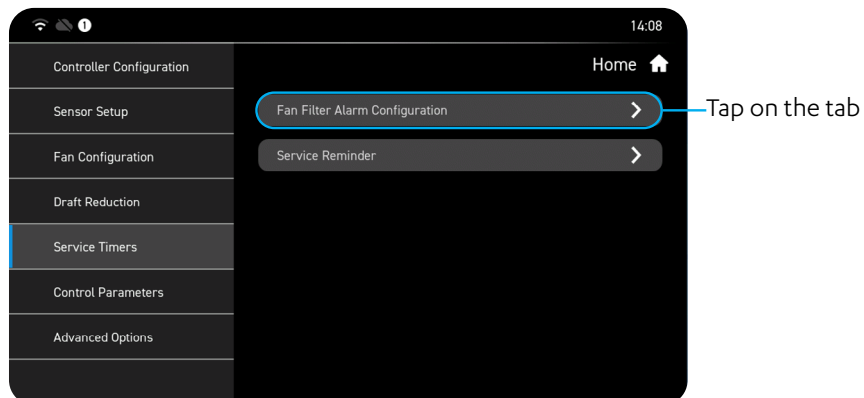

3. Make sure the **Timer Mode** is ticked. Make necessary changes on the **Duration** by clicking the  $\ominus$  or  $\oplus$  buttons. Settings are automatically saved.

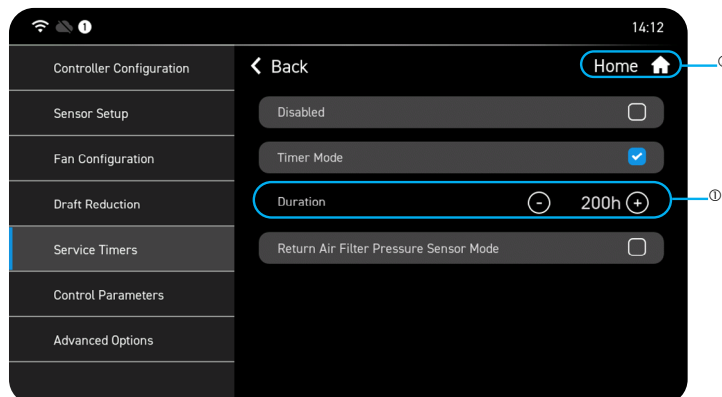

4. Click on the **Home** button on the top right corner to go back to the home screen.

## Indoor Drain Pan Overflow Sensor

In a typical air conditioning setup, the drain pan serves a vital function by gathering and expelling water from the unit. This pan is typically linked to gravity-fed drain traps, commonly referred to as P-traps. These P-traps need to be carefully designed to match the specific negative pressure of the application to ensure proper functionality and effective drainage of condensate from the unit.

However, neglecting regular servicing and maintenance of P-traps can result in blockages. When this occurs, the drain pan may also become obstructed, causing water to overflow from the unit and potentially infiltrate the building through the roof structure.

To avert such incidents, integrating an overflow sensor into the system proves beneficial. This sensor detects and prevents any potential overflow or water leakage, enhancing the system's security and dependability. By incorporating an overflow sensor, you can ensure the safe and efficient operation of your system while minimizing the risk of water damage that could lead to costly repairs.

### Location of the Indoor Drain Pan Overflow Sensor:

The Indoor Drain Pan Overflow Sensor is an optional feature, and its availability depends on the selected unit option. If this feature was opted, the sensor will be pre-installed in the drain pan near the indoor heat exchanger as shown in the diagram below.

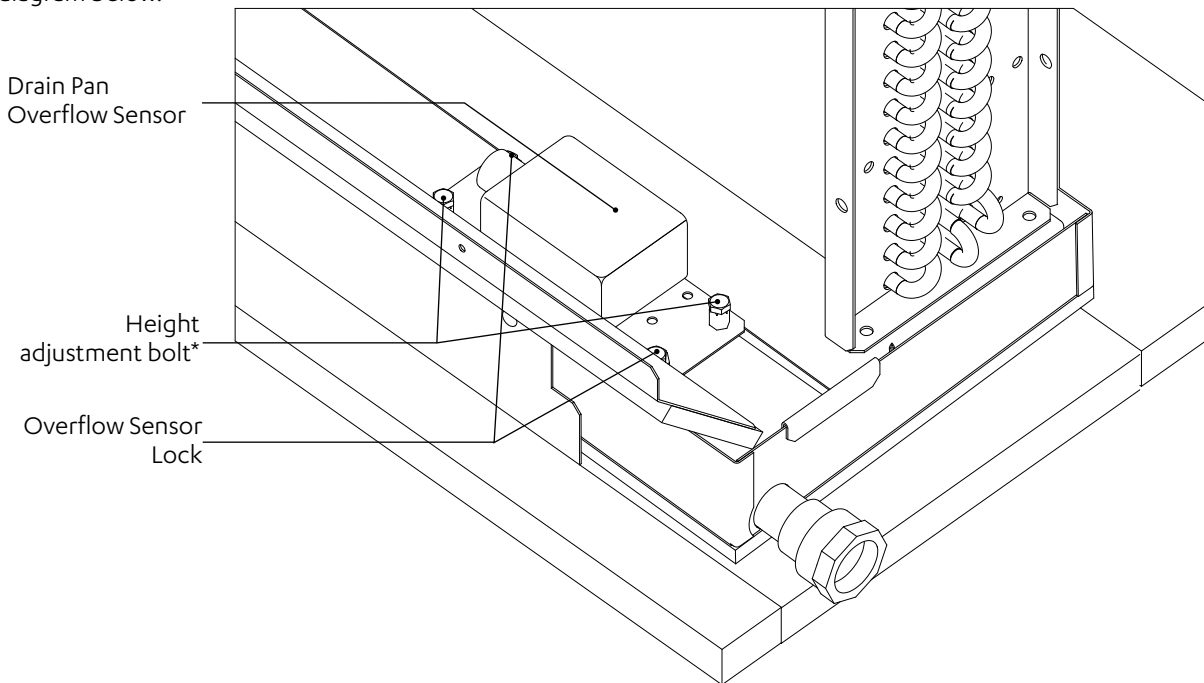

\* May be used to adjust the height of the sensor for maintenance purposes

### Enable the Indoor Drain Pan Overflow Sensor via the Control Interface as follow:

1. In the **Service and Technical** Section, select the **Advanced Options**.

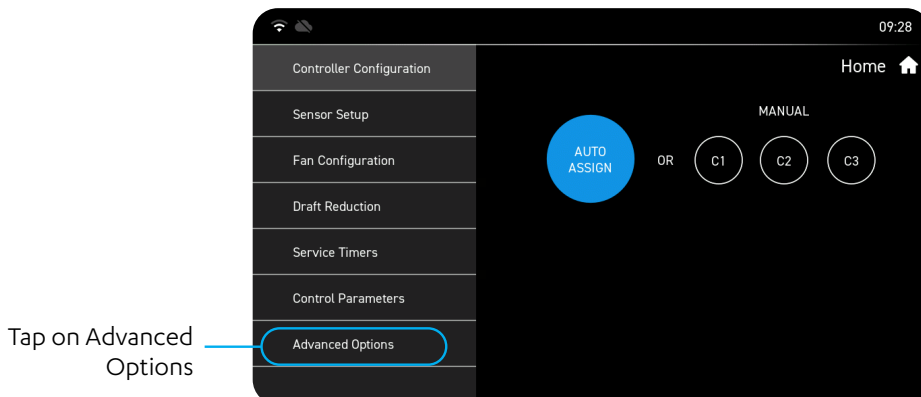

- In the Advanced Options, select **Enable Indoor Drain Pan Overflow Sensor** by tapping on the check box.

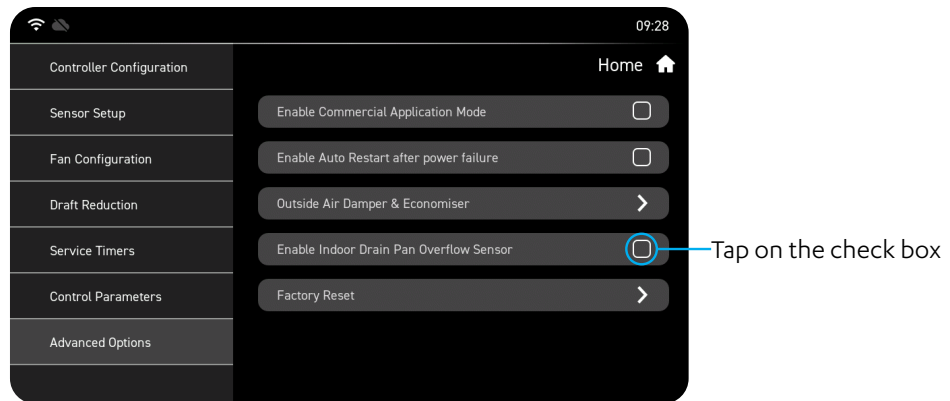

- Touch on the **Home** button on the top right corner to go back to the home screen.

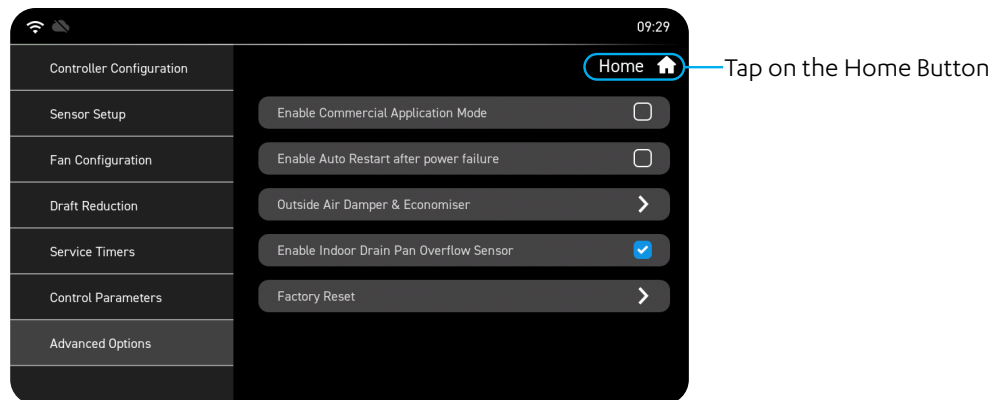

## NOTE

- When the Overflow Sensor feature is activated, the system will continuously monitor the status of the sensor.
- If no sensor trigger occurs, the system will continue to operate normally. However, if a trigger occurs, the system will automatically display a fault code, and the compressors will cease operation while the indoor fan continues to operate.
- If the unit stops working, it is recommended to check the P-trap and clean it if it is clogged. Once the water level goes down, the system will take 3 minutes to automatically reset the error code. If the issue persists, it is suggested to inspect the overflow sensor as per the wiring diagram or get in touch with ActronAir support team at **1300 522 722**.

## SETTING ECONOMY CYCLE OPERATION

The economiser system on VCC allows for controlled mixing of outside air into the return air. The purpose of the economiser is to provide outside air to reduce inside air CO<sub>2</sub> level, and reduce energy consumption in the case where the outside air can be utilised to condition the return air. The economiser system can be operated in different modes:

- Dry Bulb (standard bead sensor that comes with the base unit).
- Dry bulb with outside air enthalpy (requires outside relative humidity sensor)
- Dry bulb with inside/outside enthalpy control (requires inside and outside relative humidity sensors)

The economiser system only operates on the system when the indoor fan is running and the system is operating in cooling mode.

CO<sub>2</sub> control can also be added to all economiser options when a return air CO<sub>2</sub> sensor is installed. CO<sub>2</sub> control operates when the indoor fan is running".

### Setting Economy Cycle Type

The economy cycle operation can be set via the Control Interface as follows:

1. In the **Service and Technical** Section, select the **Advanced Options** tab.

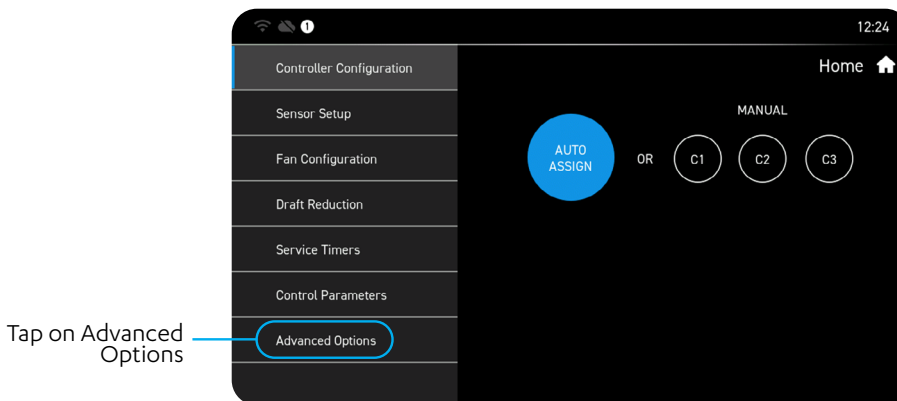

2. In **Advanced Options**, select **Outside Air Damper & Economiser** by tapping on the tab.

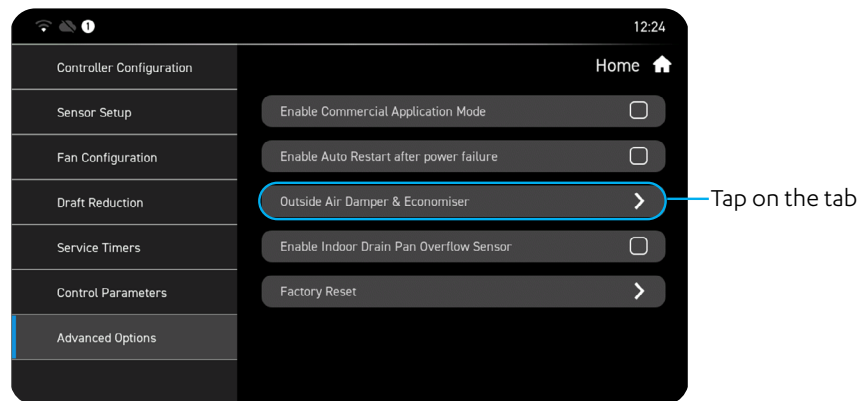

- On the next screen, enable the **Enable Outside Air Damper** by tapping on the check box.

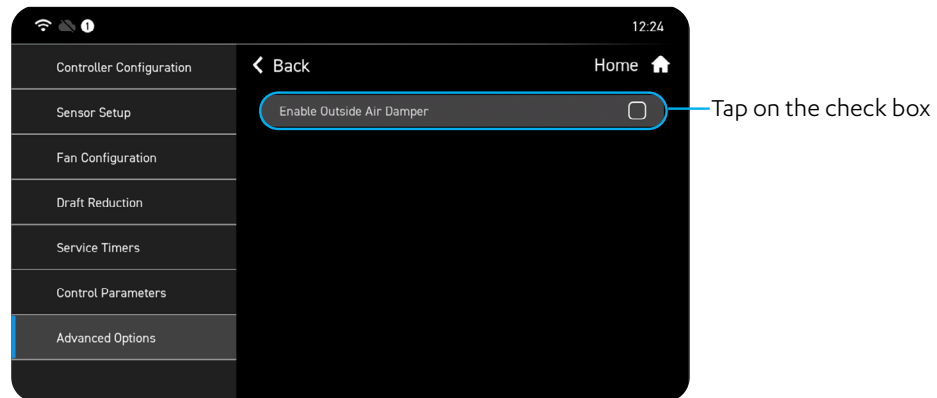

- Select **Enable Economiser** by tapping on the check box. Dry bulb control is enabled by default.

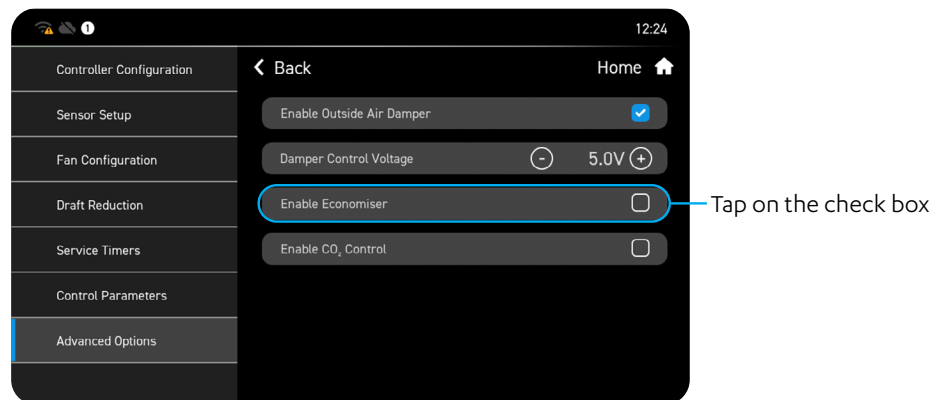

- Economiser will be enabled and the **Economiser Options** tab will appear. Tap on the **Economiser Options** tab to access settings.

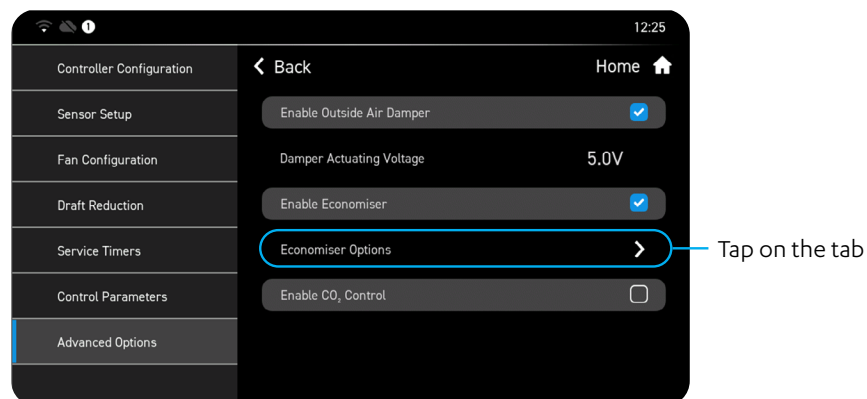

6. In the **Economiser Options** screen, tap on the **Temperature Configuration** tab to access dry-bulb control settings.

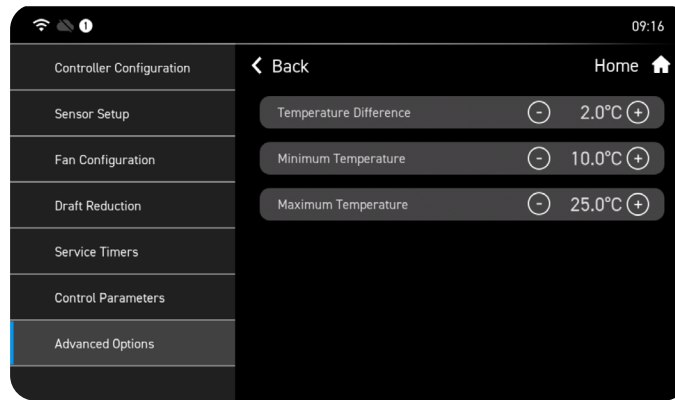
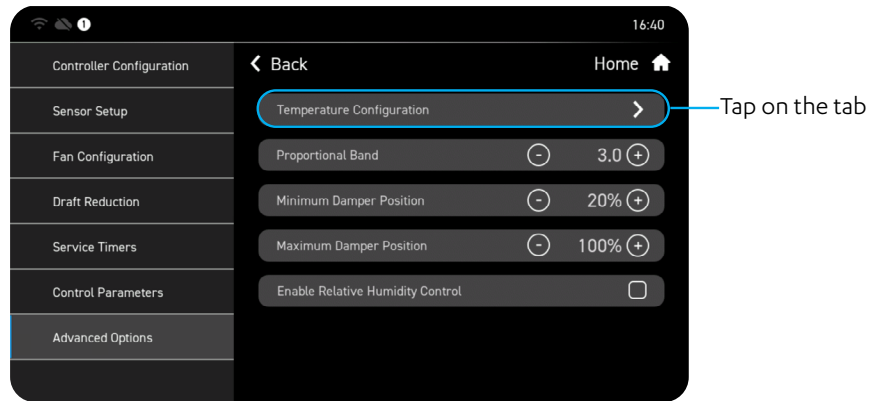

7. Still in the **Economiser Options** screen, select **Enable Relative Humidity Control** by tapping on the check box.



8. Tap **Options** to access the settings.

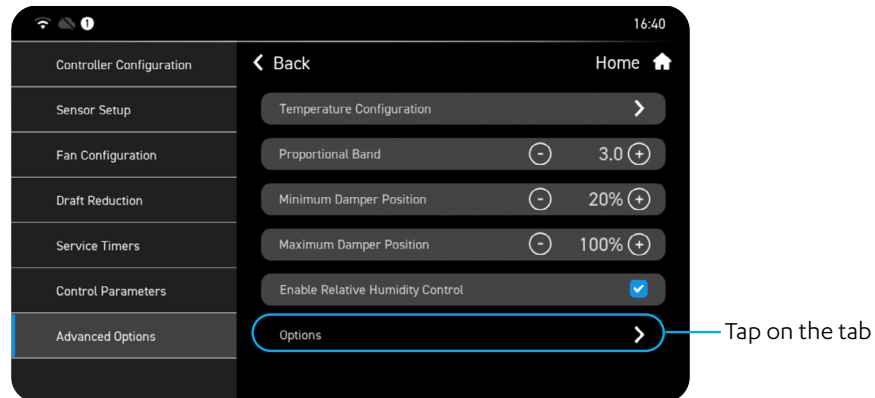

9. On the next screen, you will be able to make the necessary changes. Settings are automatically saved.

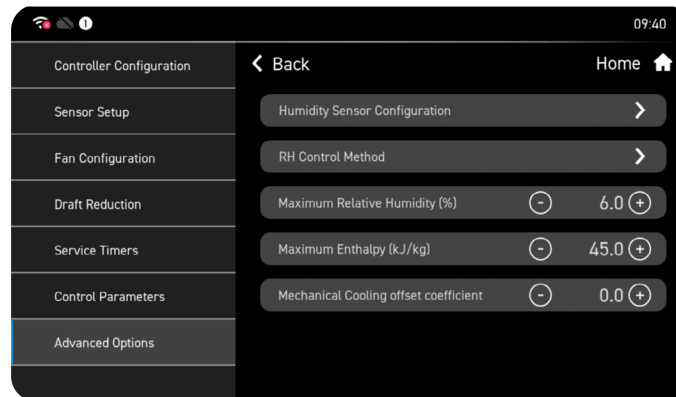

10. To change the **Humidity Sensor Configuration** setting, tap on the tab (Default - set as an outdoor RH sensor).

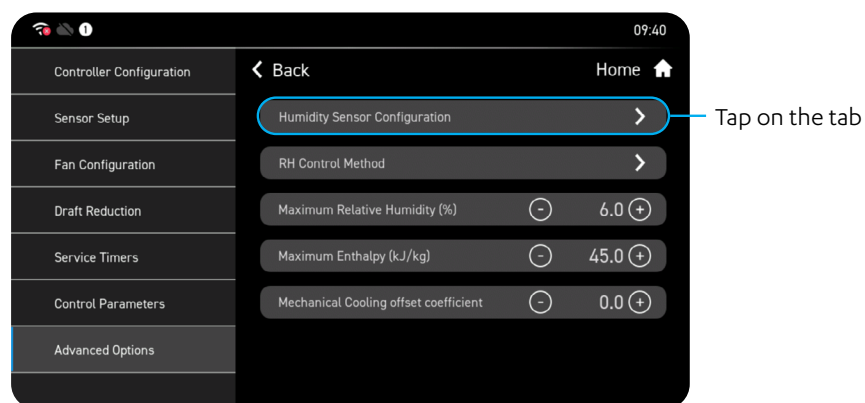

- In **Humidity Sensor Configuration**, the **Outdoor** is the default setting where the check box is. The outdoor Dry bulb with outside air enthalpy (requires outside relative humidity sensor) is enabled. Tap the **Back** button to go back to the previous screen.

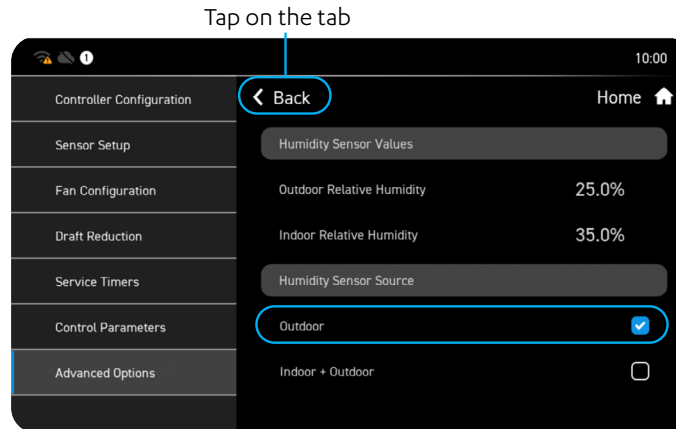

- When the **Outdoor** option is set, this disables the **Set Enthalpy Difference** option. Tap the **Humidity Sensor Configuration** tab to change the setting.

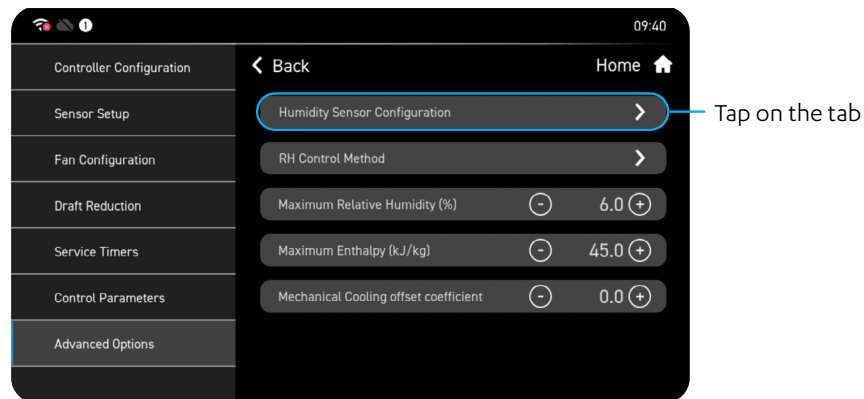

- Change the setting to **Indoor + Outdoor** to enable the **Set Enthalpy Difference** option. By tapping the **Indoor + Outdoor** Dry bulb with inside/outside enthalpy control (requires inside and outside relative humidity sensors) is enabled. Tap the **Back** button to go back to the previous screen.

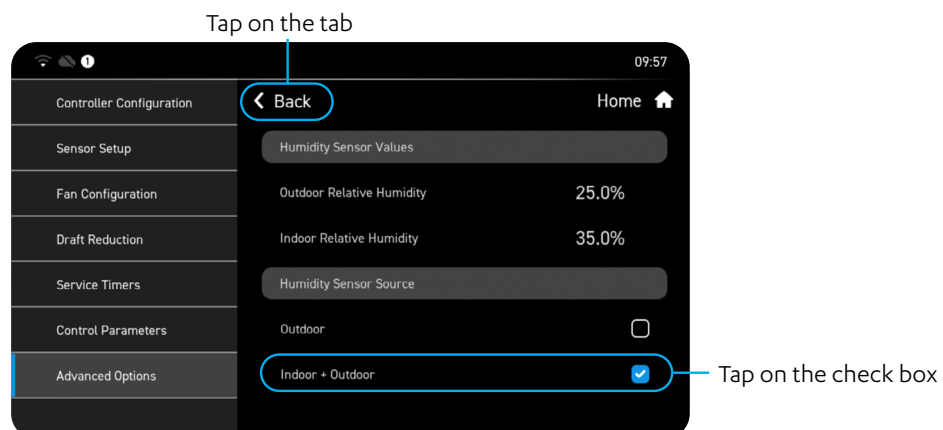



14. The **Set Enthalpy Difference** option is enabled and displayed on the screen.

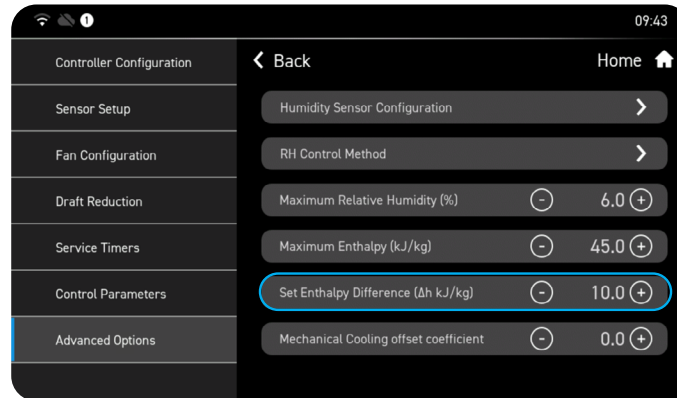

**NOTE:**

The **Set Enthalpy Difference** option is enabled if the **Humidity Sensor Configuration** is set to **Indoor + Outdoor** and disabled when set to **Outdoor**.

15. To change the **RH Control Method** setting, tap on the tab.

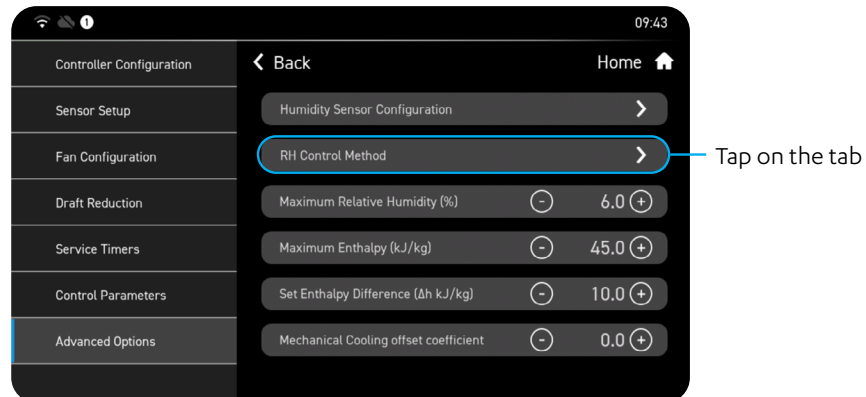

16. Tap the check box of the **Moisture Content Control** or **Dew Point Control** to make necessary changes. Settings will be automatically saved.

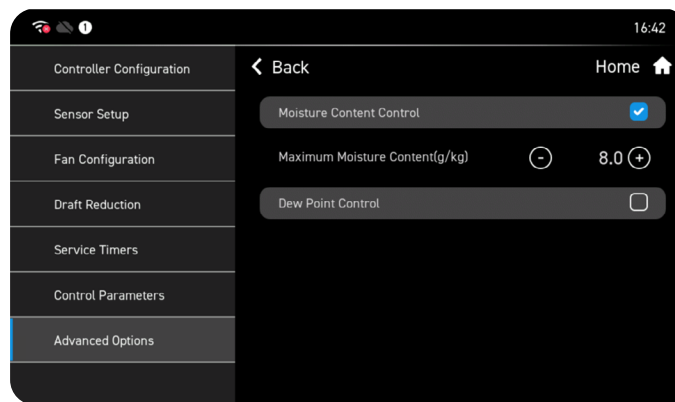
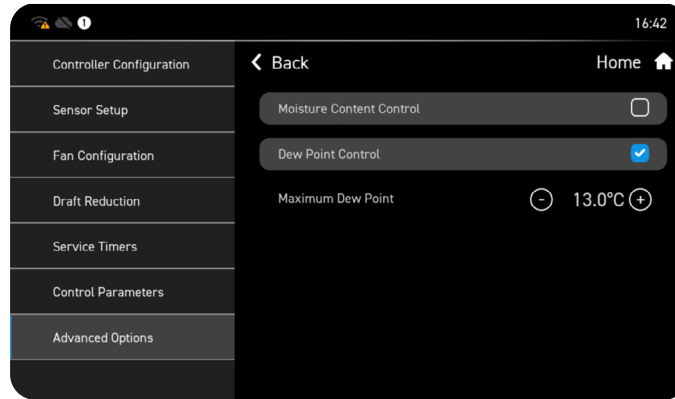

17. To Enable **CO<sub>2</sub> Control** feature, select the **Advance Options** button.

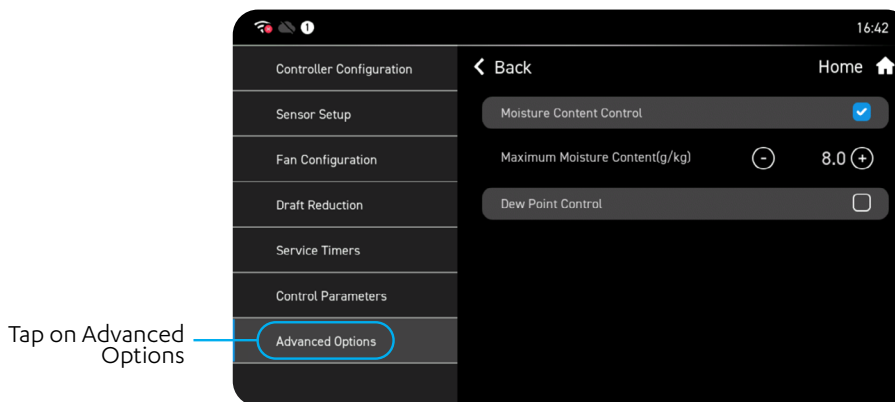

18. Tap on the **Outside Air Damper & Economiser** tab.

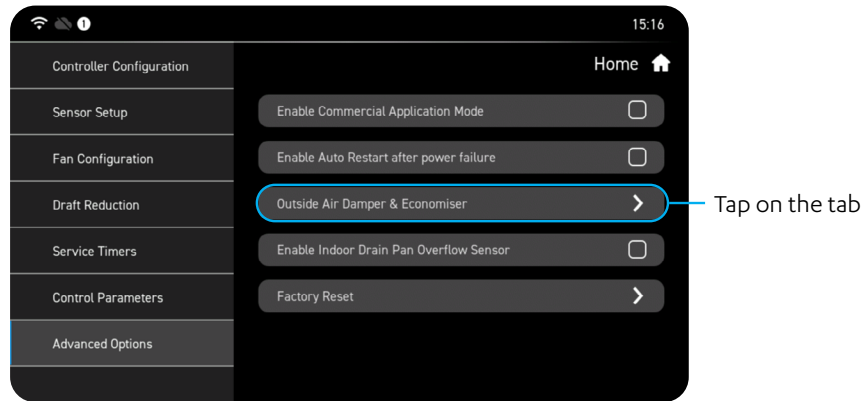

19. Select the **Enable CO<sub>2</sub> Control** by tapping on the check box.

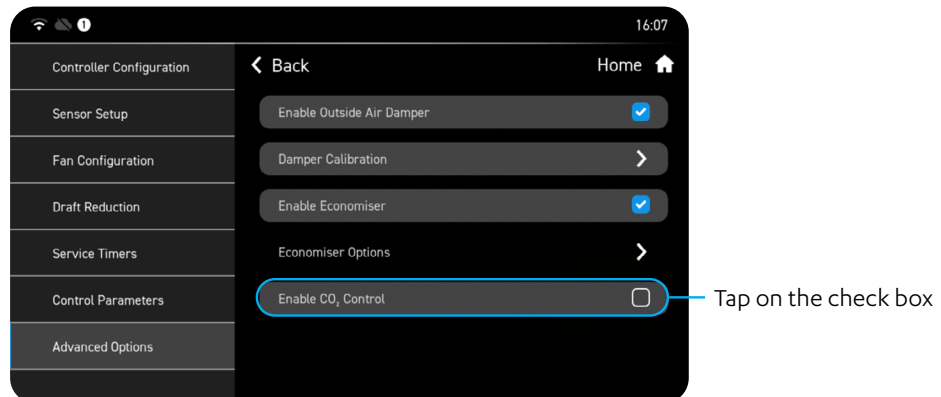

20. To change the **CO<sub>2</sub> Control Options** settings, tap on the tab.

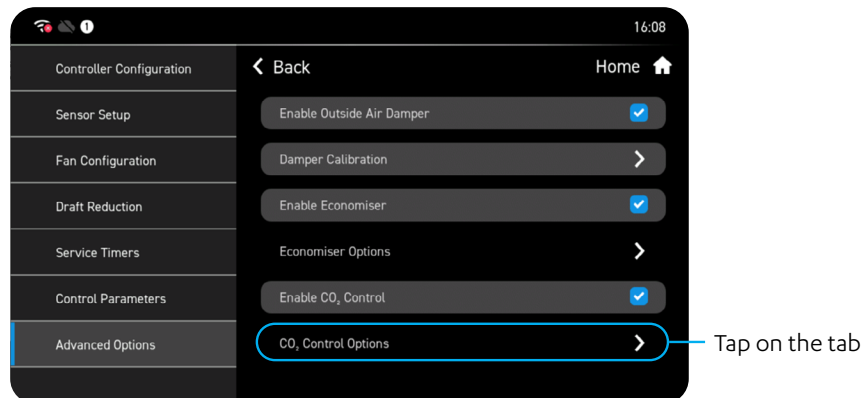

21. Make necessary changes as settings will be automatically saved.

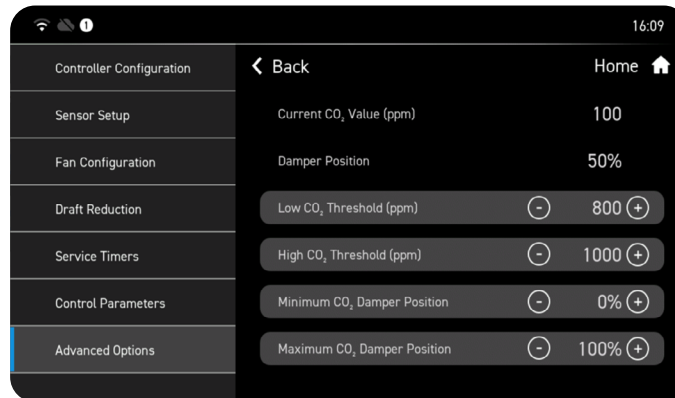

22. To go back to the **Home** screen, tap the **Home** button.

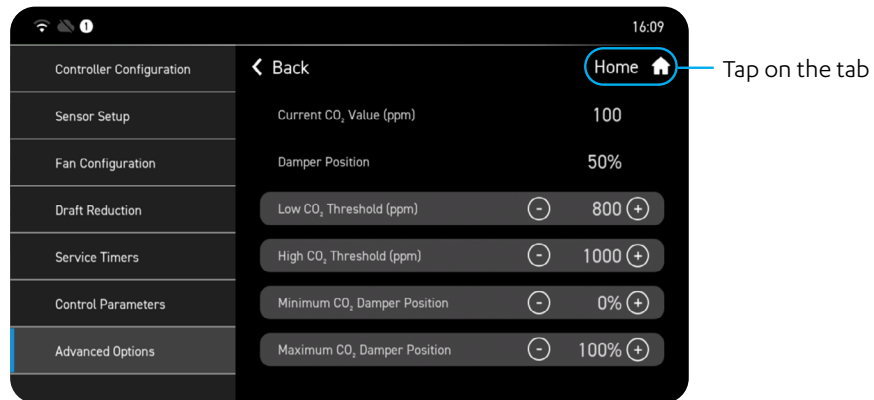

## **Bluetooth Commissioning Tool**

This application will allow end users to set up and configure VCC products by using **Actron Link** Application.

With its simple and easy to use design, this application makes advanced linking functions easy for end-users. The integrated functions and remote access capabilities ensure it is easy to install and service.

The **Actron Link** application also allows the user to retrieve the product information.

To access the **Instruction Manual (9590-3037-01)**, scan the QR Code on the Box of the Bluetooth Commissioning Tool or visit [docs.actronair.com.au](https://docs.actronair.com.au).

## Demand Response Management

These products are compliant to AS/NZS 4577.3.1:2012

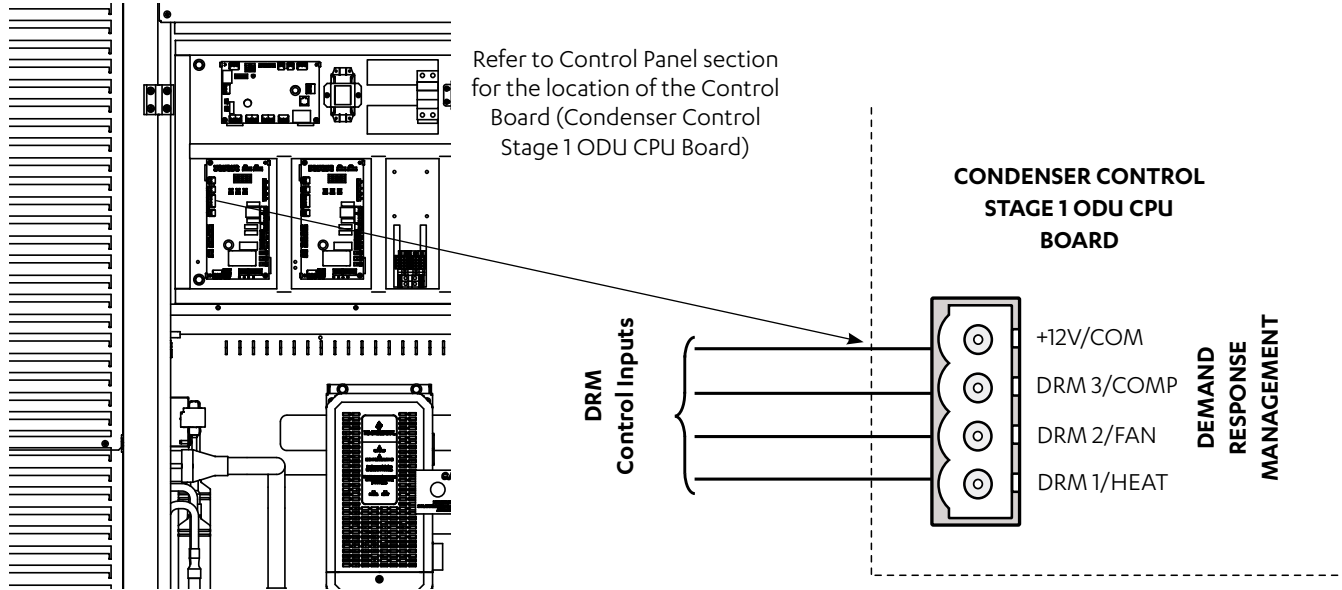

1. Route DRM input cables into the Unit (as per previous wiring installation procedure).
2. Connect cables into terminals (as per wiring diagram provided with the unit).

Demand Management Mode	Description Of Mode Allowable Range (%)	Operating Mode
DRM1	Compressor Off Mode	Compressor <u>ONLY</u> will cycle Off and remain Off for the entire Demand Response event. All other functions will operate as normal (i.e. Indoor Fan)
DRM2	Maximum 50% power use mode with 0 to <50% allowable power use range	Compressor 0 to <50% operation range for the total Demand Response event.
DRM3	Maximum 75% power use mode with 0 to <75% allowable power use range	Compressor 0 to <75% operation range for the total Demand Response event.

### DEMAND RESPONSE ENABLING DEVICE CIRCUIT DIAGRAM

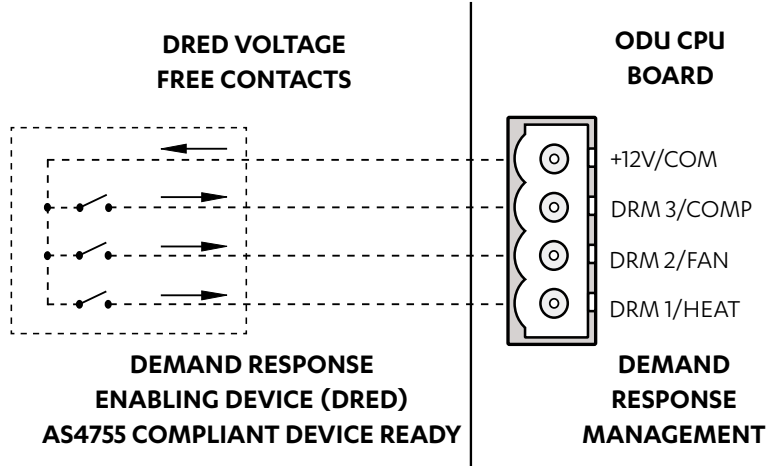

#### NOTES

- Demand Response Management is not applicable when using third party control.
- Contact your electricity authority to install and activate DRED.
- All drawings are for illustration purposes only. Actual unit may vary depending on the model.

## Third Party Control Input (Indoor and/or Outdoor Board)

This option allows Fan, Compressor and Reversing Valve to be controlled by a Third Party Control. There are two ways on how the Indoor Fan may be controlled, using 0-10V Analogue Input or Fixed Indoor Fan Speed.

**NOTE**

- Demand Response Management (DRM) is not available if Third Party Control Option is used.
- Ensure control source has been configured for Control Mode 0.
  1. On the Outdoor Board, set Control Source to Third Party. Using the MENU and the ENTER buttons, navigate to SEt (Settings) --> CtrS (Control Source).
  2. Use the MENU button to navigate to 0 to select Third Party Control as the control source. Press the ENTER button to save the setting.

### 0-10V Analogue Input for Compressor and Indoor Fan

**Indoor Fan Connection (Indoor Board)**

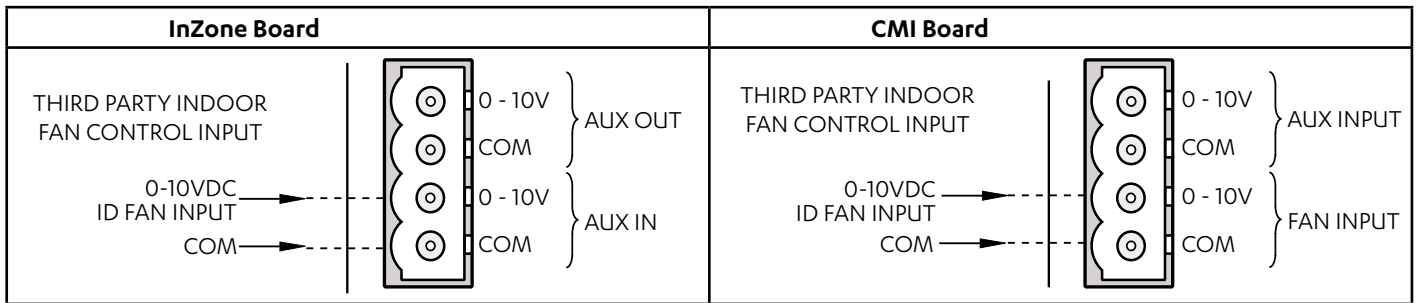

**Indoor Fan Setting (Indoor Board)**

InZone Board	CMI Board
No additional setting required.	On the indoor board ensure dip switch ONE and TWO are <b>ON</b> .
	<p>ON</p> <p>OFF</p>

Input (DC)	Output	Fan Status
0.0V to 0.99 V	0%	Off
1.0V to 1.49 V	0 or 20%	Off or On
1.5V to 9.5 V	20% to 100%	On
9.5V to 10 V	100%	On

**Compressor and Reversing Valve Connection (Outdoor Board)**

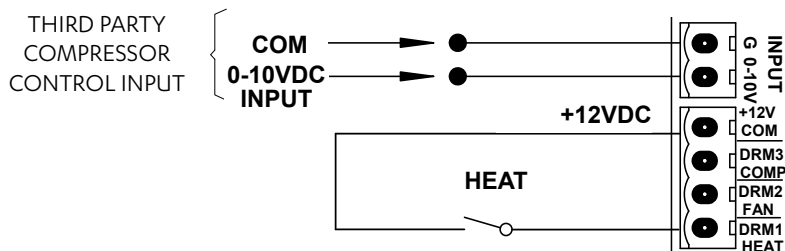

Input (DC)	Output	Compressor Status
0 - 0.99 V	0%	Off
1 - 1.49 V	0 or 20%	Off/On (hysteresis)
1.5 - 9.5 V	20% to 100%	On
9.5 - 10 V	100%	On

### NOTES

- As the compressor turns ON and the Indoor fan signal is not available then indoor fan will start to run on medium PWM speed.
- Indoor fan low and high PWM limits depends upon the model. Refer to Indoor Fan Table and Fan Curve Section.
- The Voltage can be linearly interpolated using the above table to determine the desired PWM or unit output.
- Only applicable for CMI board: If the compressor turn ON, during reduced fan operation, the controller will increase the fan speed to the "low PWM fan limit" if it is running less than the low PWM Limits.

## 0-10V Analogue Input for Compressor with Fixed Indoor Fan Speed

This feature allows for the Indoor Fan to be controlled externally (ON/OFF only).

### Indoor Fan Connection (Indoor Board) AS IS

When using fixed speed indoor fan, there would be no wiring onto the InZone nor CMI.

### Indoor Fan Setting (Indoor Board)

InZone Board	CMI Board
No additional setting required.	On the indoor board ensure that only dip switch TWO is <b>ON</b> .

### Fan, Compressor and Reversing Valve Connection (Outdoor Board)

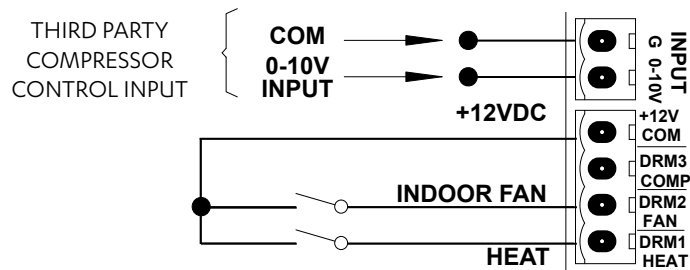

### NOTES

- As the compressor turns ON and the Indoor fan signal is not available then indoor fan will start to run on medium PWM speed.
- Indoor fan operation when fan signal is available:
  - Compressor ON : Indoor fan will run on medium speed.
  - Compressor OFF :
    - » CMI: Indoor fan will run on reduce airflow operation.
    - » InZone: Indoor fan is dependent of the controller setting.



### Input for Fixed Compressor with Fixed Indoor Fan Speed

This feature allows for both Compressor and Indoor Fan to be controlled externally (ON/OFF only).

#### Indoor Fan Setting (Indoor Board)

InZone Board	CMI Board
No additional setting required.	On the indoor board ensure that only dip switch TWO is <b>ON</b> .
	<p>ON</p>  <p>OFF</p>

#### Fan, Compressor and Reversing Valve Connection (Outdoor Board)

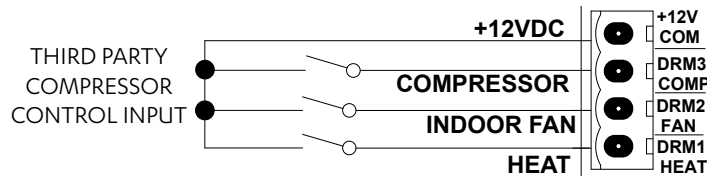

#### NOTES

- As the compressor turns ON and the Indoor fan signal is not available then indoor fan will start to run on medium PWM speed.
- Indoor fan operation when fan signal is available:
  - Compressor ON : Indoor fan will run on medium speed.
  - Compressor OFF :
    - » CMI: Indoor fan will run on reduce airflow operation
    - » InZone: Indoor fan is dependent of the controller setting.
- Compressor turns on with 100% speed request.
- Although the compressor will have 100% speed request, the speed may vary depending on compressor safety requirements. This will be shown on the outdoor board display.

### 0-10V Analogue Input for Indoor Fan with Fixed Speed Compressor

This feature allows for the compressor to be controlled externally (ON/OFF only).

#### Indoor Fan Connection (Indoor Board)

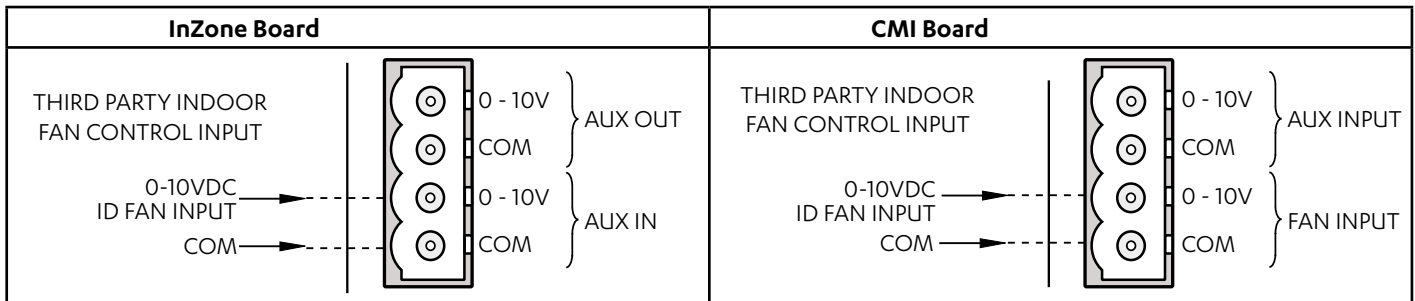

#### Indoor Fan Setting (Indoor Board)

InZone Board	CMI Board
No additional setting required.	On the indoor board ensure dip switch ONE and TWO are <b>ON</b> .
	<p>ON</p>  <p>OFF</p>

Input (DC)	Output	Fan Status
0.0 V to 0.99 V	0%	Off
1.0 V to 1.49 V	0 or 20%	Off or On
1.5 V to 9.5 V	20% to 100%	On
9.5 V to 10 V	100%	On

### Fan, Compressor and Reversing Valve Connection (Outdoor Board)

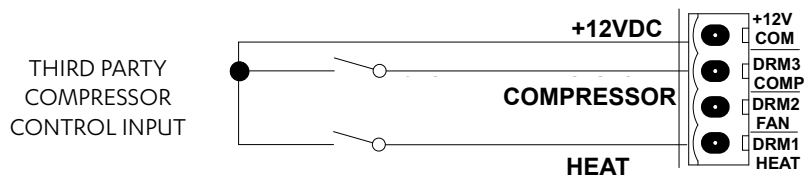

#### NOTES

- As the compressor turns ON and the Indoor fan signal is not available then indoor fan will start to run on medium PWM speed.
- If the compressor turn ON, during reduced fan operation, the controller will increase the fan speed to the "low PWM fan limit" if it is running less than the low PWM Limits.
- Indoor fan low and high PWM limits depends upon the model.
- The Voltage can be linearly interpolated using the above table to determine the desired PWM or unit output.
- Compressor turns on with 100% speed request.

### Run and Fault Indication Output (Outdoor Board)

To activate, the unit must be wired as illustrated below. If required, a fault output connection terminal is also available to show any error/fault with the a/c system. RUN/FAULT relay outputs (230VAC/5A MAX) connection.

#### Run Indication

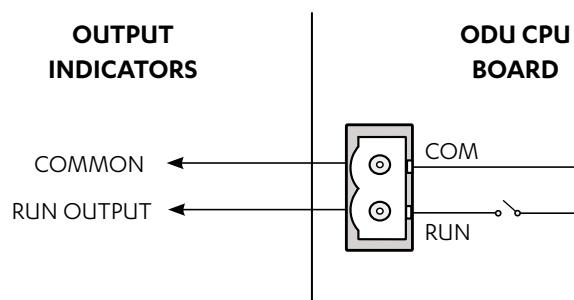

Run Output is configurable to indicate that the unit is running. There are two configurations in which this can be set:

- Either the compressor or the Indoor Fan only is running
- Only Compressor is running.

By default, this is set to turn on when either indoor fan or compressor is operating. To set up to compressor run indication only, in OD Board Menu follow below steps.

1. Using the **MENU** and the **ENTER** Buttons on the outdoor PCB, navigate to **SEt** (Settings) → **run** (Unit Operation Indicator Settings).

- If required, press **MENU** to navigate to **YES**.

## Fault Indication

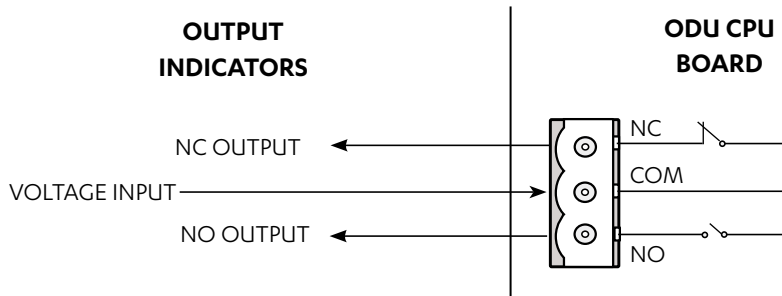

To indicate any system fault, outdoor controller will provide a signal through the Fault Indication relay. An installer can use either NC or NO output as per their requirements.

## Remote On/Off

To activate, the unit must be wired as illustrated below. This will enable unit to be turned ON and OFF from the Outdoor board.

### NOTES

The system must be operating in Wall Controller only (control mode 1) or BMS + Wall Controller (control mode 3) for this function to work.

- On the Outdoor Board, set Control Source to Third Party. Using the MENU and the ENTER buttons, navigate to SEt (Settings) --> CtrS (Control Source).
- Use the MENU button to navigate to "1" or "3" to select "Wall Controller only" or "BMS + Wall Controller" as the control source. Press the ENTER button to save the setting.

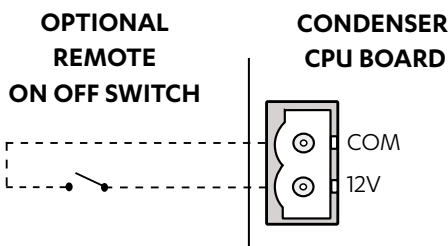

### Turning the system On and Off by remote method

Turning the system On	Status 1: The system is Off and the remote switch/relay has been left in the open position. <ol style="list-style-type: none"> <li>Close remote switch/relay.</li> <li>System will start in approximately in 30 seconds.</li> </ol>
	Status 2: The system is Off and the remote switch/relay has been left in the closed position. <ol style="list-style-type: none"> <li>Open remote switch/relay for a minimum of 5 seconds.</li> <li>Close remote switch/relay.</li> <li>System will start in approximately in 30 seconds.</li> </ol>
Turning the system Off	Status 3: The system is On and the remote switch/relay has been left in the closed position. <ol style="list-style-type: none"> <li>Open remote switch/relay.</li> <li>System will turn Off in approximately in 30 seconds.</li> </ol>
	Status 4: The system is On and the remote switch/relay has been left in the open position. <ol style="list-style-type: none"> <li>Close remote switch/relay for a minimum of 5 seconds.</li> <li>Open remote switch/relay.</li> <li>System will turn Off in approximately in 30 seconds.</li> </ol>

## Fan Performance Data and Curve

### PKV720T

FAN DATA																							
AIRFLOW (l/s)		EXTERNAL STATIC PRESSURE (Pa)																					
		50		100		150		200		250		300		350		400		450		500			
		% SPD	W	% SPD	W	% SPD	W	% SPD	W	% SPD	W	% SPD	W	% SPD	W	% SPD	W	% SPD	W	% SPD	W		
1*	1000	32	350	39	211	47	365	53	456	58	607	64	716	68	900	72	1068	76	1160	78	1360		
	1500	41	413	47	421	53	568	58	709	63	873	67	1028	71	1202	75	1390	78	1542	82	1749		
2*	1700	45	439	50	510	56	654	61	815	65	985	69	1160	73	1329	77	1525	80	1702	84	1912		
	2000	50	475	55	631	59	772	64	961	68	1139	72	1341	75	1504	79	1712	83	1924	87	2137		
	2500	60	756	64	932	68	1139	71	1302	75	1523	78	1695	82	1927	85	2105	88	2332	91	2560		
	3000	70	1145	73	1343	76	1534	79	1709	83	1979	86	2199	89	2434	92	2682	96	3022	98	3189		
3*	3500	79	1545	82	1780	85	2016	88	2281	91	2558	94	2856	96	3055	98	3253	<b>MOTOR /BLOWER LIMIT</b>					
	<b>3800</b>	85.6	1969	88	2189	<b>91</b>	<b>2472</b>	93	2704	96	2940	98	3184										
	4000	90	2251	92	2461	95	2776	97	2985	99	3195												
	4500	99	2854																				

- \* 1 Airflow during compressor OFF operation.
- 2 Airflow during Safe Mode, see the fan curve for detailed information.
- 3 Capacity Selection Range - See the Airflow Correction Multiplier for details.

#### NOTES:

**% Speed** = Indoor Fan Speed Control Setting, in percent

**W** = Indoor Fan Power, Watts

   Bold data in the box indicates Factory Default Setting.

High speed limit may be outside the fan curves at lower static condition which needs to be taken care while operating the unit.

Indoor Fan % SPD Limits	
High Spd. Limit (%)	99
Low Spd. Limit (%)	32

PKV720T : Third Party Application Fan Curve

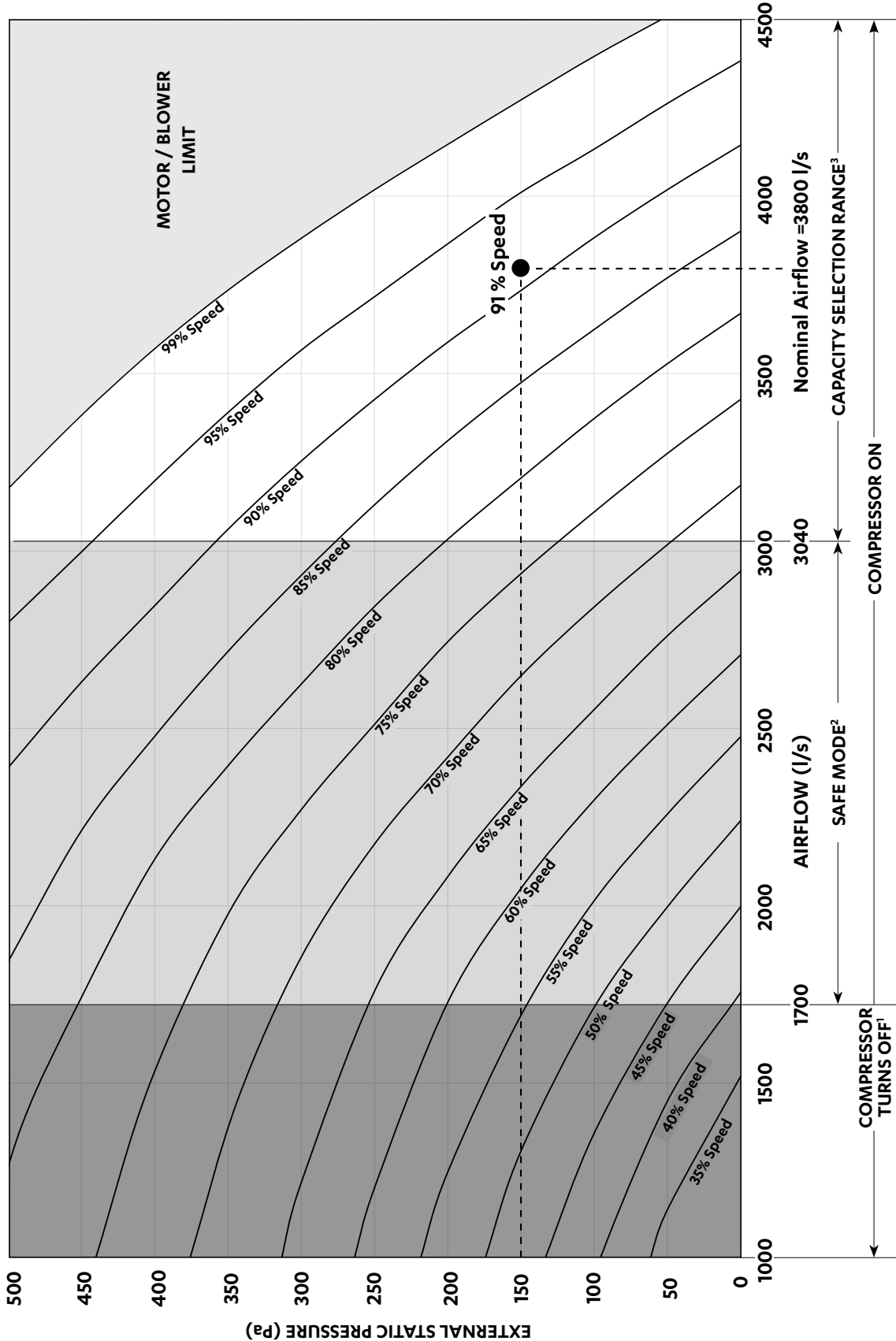

**NOTE**

- 1 When the airflow goes below the lower limit of the Safe Mode, the compressor turns off; the fan will continue to run.
  - 2 System safety logic may be activated
- Fan Performance Data and Fan Curve shown is at dry coil and with no air filters installed. Consider external static pressure drop specific to your design requirements. Airflow should be reduced with respect to the moisture content in the air. Please review filter manufacturer for application. 2.5 m/s face velocity point will occur outside the application range.

PKV850T

FAN DATA																			
AIRFLOW (l/s)		EXTERNAL STATIC PRESSURE (Pa)																	
		100		150		200		250		300		350		400		450		500	
		% SPD	W	% SPD	W	% SPD	W	% SPD	W	% SPD	W	% SPD	W	% SPD	W	% SPD	W	% SPD	W
1*	1200	38	258	44	425	49	516	55	736	60	903	65	1160	69	1361	73	1589	76	1687
	1500	39	309	45	481	51	645	56	813	61	997	66	1272	70	1485	74	1722	77	1826
2*	2000	43	480	48	660	54	843	59	1038	64	1236	68	1498	73	1870	76	2019	79	2103
	2500	47	616	53	851	58	1081	62	1258	67	1574	71	1844	75	2153	78	2328	81	2543
	3000	53	831	58.1	1092	62	1316	66	1562	70	1836	74	2152	77	2404	80	2613	84	3012
	3500	58	1040	62	1285	66	1547	70	1841	74	2186	77	2457	80	2738	83	3039	87	3438
3*	4000	64	1332	68	1634	71	1880	74	2166	78	2541	81	2844	84	3183	87	3527	91	4020
	<b>4450</b>	69	1615	<b>72</b>	<b>1907</b>	76	2275	79	2550	82	2922	85	3271	87	3531	90	3925	94	4429
	4500	70	1680	73	1974	76	2275	79	2593	82	2922	85	3271	88	3658	91	4068	95	4540
	5000	75	2027	78	2350	81	2706	84	3078	87	3465	89	3750	92	4177	95	4634	98	5029
	5350	79	2291	82	2655	85	3079	88	3496	90	3811	93	4343	96	4732	98	5042		

- \* 1 Airflow during compressor OFF operation.
- 2 Airflow during Safe Mode, see the fan curve for detailed information.
- 3 Capacity Selection Range - See the Airflow Correction Multiplier for details.

NOTES:

**% Speed** = Indoor Fan Speed Control Setting, in percent

**W** = Indoor Fan Power, Watts

   Bold data in the box indicates Factory Default Setting.

High speed limit may be outside the fan curves at lower static condition which needs to be taken care while operating the unit.

Indoor Fan % SPD Limits	
High Spd. Limit (%)	99
Low Spd. Limit (%)	38

PKV850T : Third Party Application Fan Curve

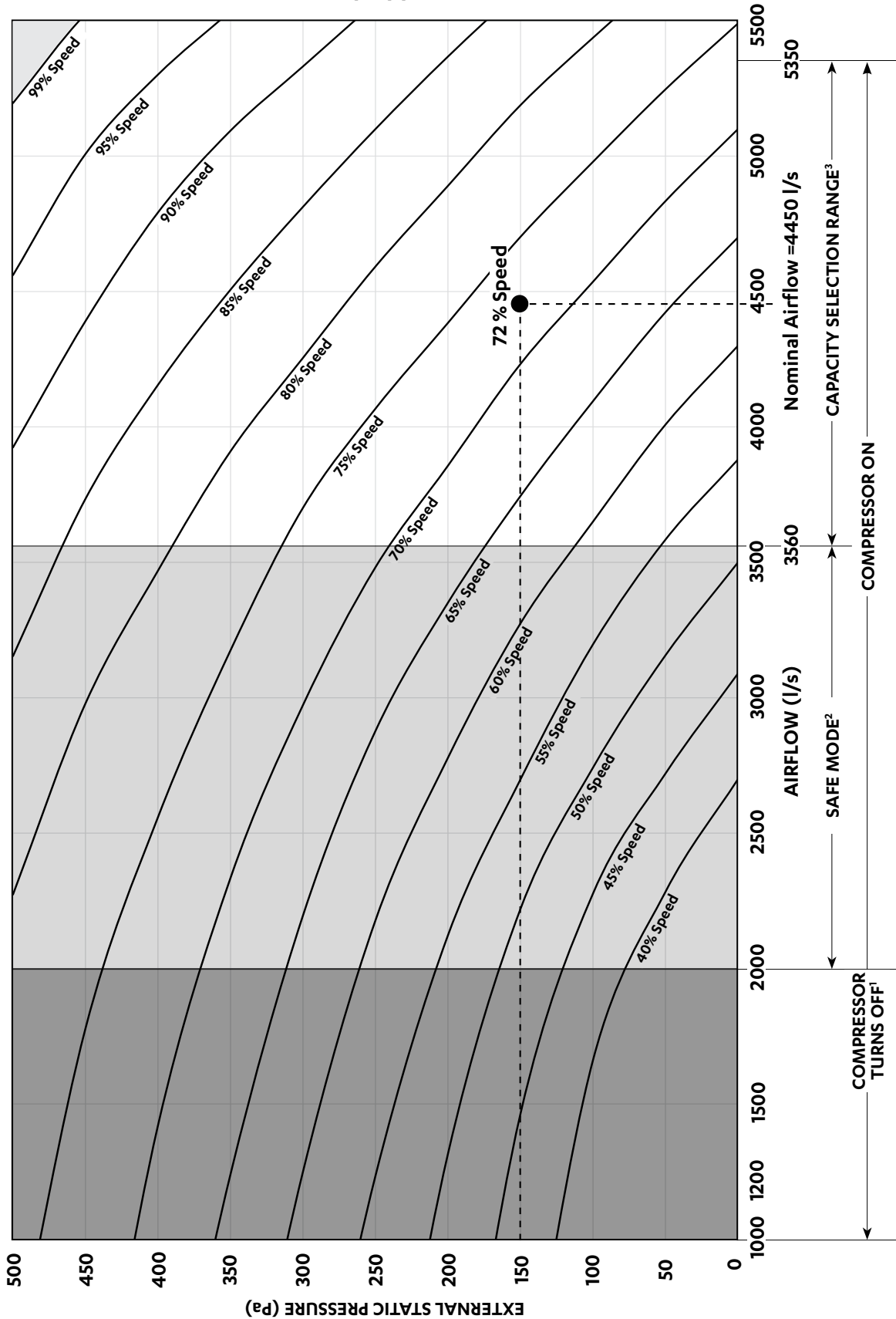

**NOTE**

- 1 When the airflow goes below the lower limit of the Safe Mode, the compressor turns off; the fan will continue to run.
- 2 System safety logic may be activated

Fan Performance Data and Fan Curve shown is at dry coil and with no air filters installed. Consider external static pressure drop specific to your design requirements. Airflow should be reduce with respect to the moisture content in the air. Please review filter manufacturer for application. 2.5 m/s face velocity point will occur outside the application range.

PKV960T

FAN DATA																			
AIRFLOW (l/s)		EXTERNAL STATIC PRESSURE (Pa)																	
		100		150		200		250		300		350		400		450		500	
		% SPD	W	% SPD	W	% SPD	W	% SPD	W	% SPD	W	% SPD	W	% SPD	W	% SPD	W	% SPD	W
1*	1250	40	390	45	501	51	651	56	816	60	904	65	1181	69	1399	73	1686	76	1774
	1500	41	439	46	551	52	752	57	924	61	1005	66	1306	70	1540	74	1837	77	1947
	2000	44	536	49	700	54	887	59	1069	64	1308	68	1554	72	1823	76	2140	79	2293
2*	2500	48	671	53	882	58	1113	62	1296	67	1611	71	1909	75	2248	78	2443	81	2637
	3000	53	859	57	1064	62	1339	66	1603	70	1913	74	2228	77	2471	80	2745	83	2980
	3500	58	1069	62	1316	66	1590	70	1911	73	2166	77	2526	80	2805	83	3136	87	3614
	4000	64	1367	67	1618	71	1953	74	2227	77	2519	81	2925	84	3256	87	3659	90	4053
3*	4500	69	1682	73	2035	76	2343	79	2663	82	3013	85	3370	88	3772	91	4203	93	4527
	<b>5000</b>	75	2090	<b>78</b>	<b>2445</b>	81	2797	84	3182	86	3455	89	3873	92	4323	95	4800	98	5320
	5500	80	2530	83	2932	86	3337	89	3753	91	4064	94	4573	96	4917	98	5310		
	6000	86	3180	89	3623	92	4034	94	4360	97	4969	99	5382	<b>MOTOR /BLOWER LIMIT</b>					

- \* 1 Airflow during compressor OFF operation.
- 2 Airflow during Safe Mode, see the fan curve for detailed information.
- 3 Capacity Selection Range - See the Airflow Correction Multiplier for details.

NOTES:

**% Speed** = Indoor Fan Speed Control Setting, in percent

**W** = Indoor Fan Power, Watts

   Bold data in the box indicates Factory Default Setting.

High speed limit may be outside the fan curves at lower static condition which needs to be taken care while operating the unit.

Indoor Fan % SPD Limits	
High Spd. Limit (%)	99
Low Spd. Limit (%)	40



PKV960T : Third Party Application Fan Curve

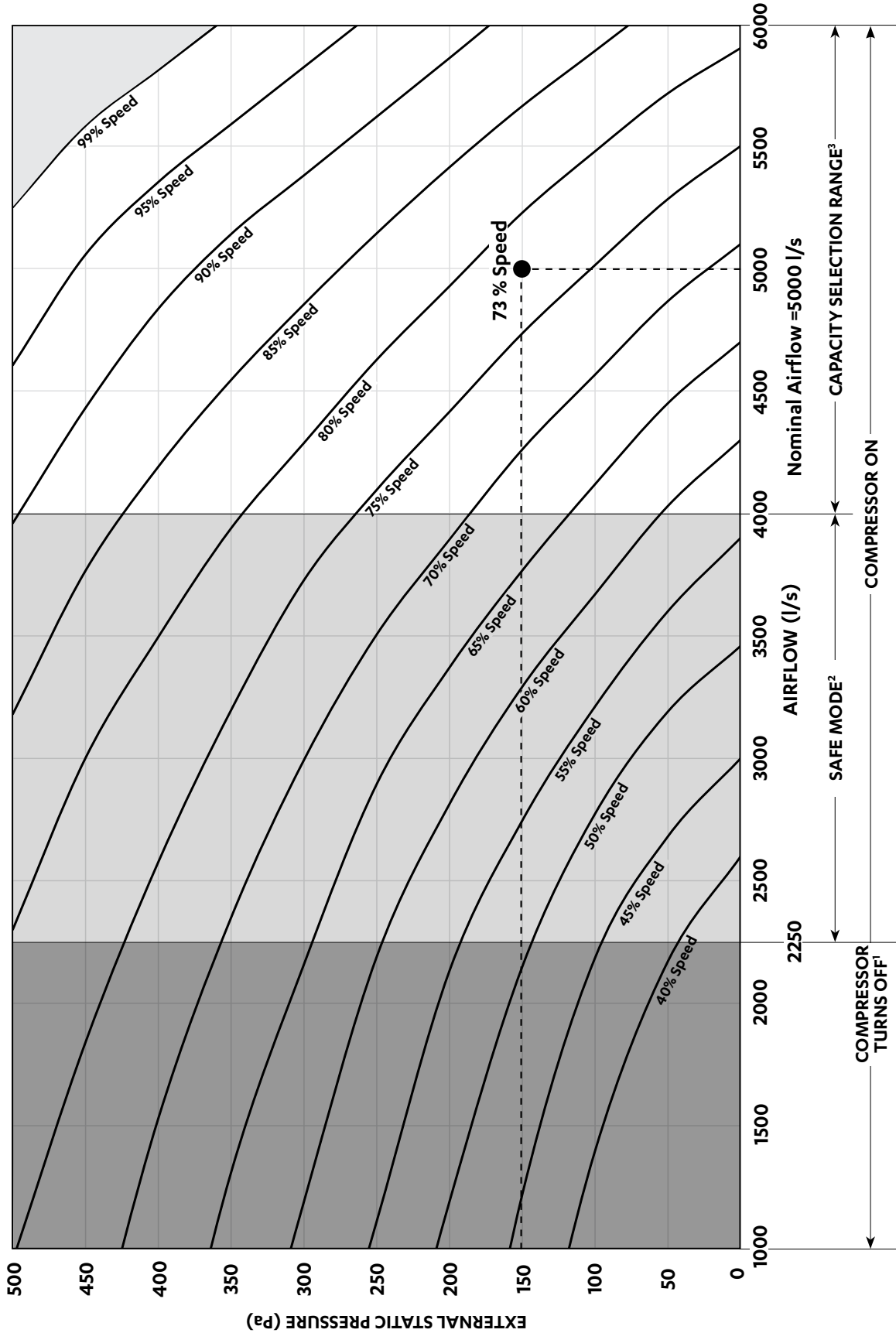

**NOTE**

- 1 When the airflow goes below the lower limit of the Safe Mode, the compressor turns off; the fan will continue to run.
  - 2 System safety logic may be activated
- Fan Performance Data and Fan Curve shown is at dry coil and with no air filters installed. Consider external static pressure drop specific to your design requirements. Airflow should be reduced with respect to the moisture content in the air. Please review filter manufacturer for application. 2.5 m/s face velocity point will occur outside the application range.

## SENSOR DETAIL

OUTDOOR SENSORS			
Sl.No.	Description	Location	ActronAir Part Number
1	Compressor 1 Discharge Temp. Sensor	Compressor 1 Discharge line	S2060-121-DLT1
2	Compressor 2 Discharge Temp. Sensor	Compressor 2 Discharge line	S2060-121-DLT2
3	Outdoor Coil 1 Temperature Sensor	Last return bend of Coil system 1	S2060-121-COIL1
4	Outdoor Coil 2 Temperature Sensor	Last Return Bend of Coil system 2	S2060-121-COIL1
5	Ambient Air Temperature Sensor	Outdoor Coil System 2 Air Inlet side	S2060-121-AMB
6	Suction Sensors Stage 1	Suction Line 1	S2060-121-SCT1
7	Suction Sensors Stage 2	Suction Line 2	S2060-121-SCT2
8	HP Pressure Sensor	Compressor 1 Discharge line	2060-126
9	HP Pressure Sensor	Compressor 2 Discharge line	2060-126
10	LP Pressure Sensor	Suction Line 1	2060-125
11	LP Pressure Sensor	Suction Line 2	2060-125

INDOOR SENSORS			
Sl.No.	Description	Location	ActronAir Part Number
1	Indoor Coil Temperature Sensor	Indoor Coil	2060-017

SWITCHES				
Sl.No.	Description	Location	Type	ActronAir Part Number
1	Compressor 1 High Pressure Switch	Compressor 1 Discharge Line	Pressure Switch	2060-019
2	Compressor 2 High Pressure Switch	Compressor 2 Discharge Line	Pressure Switch	2060-019
3	Compressor 1 Low Pressure Switch	Compressor 1 Suction Line	Pressure Switch	2060-123
4	Compressor 2 Low Pressure Switch	Compressor 2 Suction Line	Pressure Switch	2060-123

## Refrigerant Charging

- The unit is supplied with factory-charged R-410A refrigerant as stated in the Rating Label. The use of other materials as a refrigerant may cause explosions and/or personal injury.
- Be aware of all the relevant regulations concerning the handling of refrigerant.
- The system of this unit operates with Polyolester (POE)\* oil.
- It is important to work with absolute cleanliness.
- Brazing must be done with the use of Nitrogen to avoid carbon deposits into the pipes.
- The system must be evacuated thoroughly to 500 microns (see evacuation procedure).
- Never allow refrigerant to vent into the atmosphere. It is an offence to release refrigerant in Australia.
- Always reclaim refrigerant using equipment and container dedicated for the refrigerant used in the system.
- Only qualified technicians are allowed to perform any work described in this guide.
- All work must be carried out in accordance with Australia and New Zealand refrigerant handling code of practice.
- Where crankcase heaters are in operation, ensure to power up the unit for a minimum of 3 hours prior to starting the compressor. For colder climates, a longer time period may be required.
- R-410A refrigerant must always be charged in liquid state. Always charge refrigerant in the unit liquid line. The air conditioning system should always be liquid charged from the cylinder. When the system is in a vacuum, always charge into the high pressure side. Although it is acceptable to charge refrigerant into the discharge service port, but the liquid line service port on the shut-off valve is recommended.
- Only during the compressor running condition can the system be charged through the suction service port on the compressor suction line.
- When the system is operating in cooling mode, it can be charged through the service port on the suction line ball valve (larger of the two shut off valves). This ensures the liquid refrigerant goes into the accumulator and then slowly enters the compressor.
- Remember, the pressure in this shut-off valve port will be high during heating mode, so the above method is not possible. The system can be charged through the suction service port on the compressor suction line. But be careful not to charge too much refrigerant at once, let the liquid enter in short bursts by opening and closing your gauges.
- Changes in refrigerant charge must be noted on a label that is fixed to the unit for future reference.

### CAUTION

R-410A refrigerant has POE oil that rapidly absorbs moisture. The maximum time any system can be opened to atmosphere is 15 minutes.

Model	PKV720T		PKV850T		PKV960T	
Circuit No.	Circuit-1	Circuit-2	Circuit-1	Circuit-2	Circuit-1	Circuit-2
Refrigerant type	R410A		R410A		R410A	
Factory charge (gm)	12900	12900	12830	13330	16900	17200

## Charging Method: Subcooling and Superheat

### Parameters:

**LLT** = Liquid Line Temperature

**SLT** = Suction Line Temperature

**SCT** = Saturated Condensing Temperature

**SST** = Saturated Suction Temperature

### Cooling and Heating Operation:

Adjust the refrigerant charge to obtain the correct super heat and sub-cool for optimal performance as follows:

1. Ensure that air filters are fitted and total system airflows are achieved. (Air filters are not supplied with the unit, it is the responsibility of the installing contractor to provide and fit adequate return air and fresh air filters).
2. Connect service gauges to the shut off valves.
3. Start the unit in cool mode ensuring that the compressor is in operation before taking service gauges reading. Allow the system to stabilise for the next 15 - 30 minutes before recording.

- Record the discharge pressure, suction pressure, liquid line temperature and suction line temperature for all the refrigeration circuits.

**Circuit 1**

Discharge Pressure = \_\_\_\_\_ kPa      Suction Pressure = \_\_\_\_\_ kPa

Liquid Line Temperature (LLT) = \_\_\_\_\_ °C      Suction Line Temperature (SLT) = \_\_\_\_\_ °C

**Circuit 2**

Discharge Pressure = \_\_\_\_\_ kPa      Suction Pressure = \_\_\_\_\_ kPa

Liquid Line Temperature (LLT) = \_\_\_\_\_ °C      Suction Line Temperature (SLT) = \_\_\_\_\_ °C

**NOTES**

- Accurate pressure and temperature measuring tools should be used to achieve satisfactory results.
- The sensors of thermocouple must be in good contact with the area being measured and must be insulated in order to obtain correct reading.

**Checking for Subcooling**

- From the Pressure / Temperature Chart, record the corresponding Saturated Condensing Temperature (SCT) at the given discharge pressure.
- Calculate the system subcooling using the formula below:

**Subcooling = SCT - LLT**

- If subcooling is within the range (see charging table), there is no need to add/remove refrigerant.
  - If subcooling is lower than minimum, the system is undercharged, it is necessary to add refrigerant.
  - If subcooling is higher than maximum, the system is overcharged, it is necessary to remove refrigerant.

Allow the systems to stabilise (15 - 30 mins) and repeat the steps 1-3 until subcooling falls within the range specified in the Subcooling/Superheat Table below.

**Checking for Superheat**

Maintaining the correct superheat is important for ensuring the evaporator is achieving maximum capacity and avoiding excessive liquid refrigerant returning to the compressor.

- From the Pressure/Temperature Chart, record the corresponding Saturated Suction Temperature (SST) at the given suction pressure.
- Calculate the system super heat using the formula below:

**Superheat = SLT - SST**

- If superheat is within the range (see charging table), there is no need to add/remove refrigerant.
  - If superheat is lower than minimum, it means that liquid refrigerant may be returning to the compressor. It is necessary to remove refrigerant or check EEV settings.
  - If superheat is higher than maximum, it means that refrigeration capability of the evaporator is not fully maximised. It is necessary to add refrigerant charge or check EEV settings.

Allow the systems to stabilise (15 - 30 mins) and repeat the steps 1-3 until superheat falls within the range specified in the table below.

Subcooling/Superheat Table			
Cooling		Heating	
Subcooling	Superheat	Subcooling	Superheat
4 - 8	2 - 8	10 - 14	2 - 8

## NOTES

The above subcooling and superheat recommendations are based on the following rated conditions:

- Cooling: 35°C DB outdoor, air entering indoor at 27°C DB / 19°C WB.
- Heating: 7°C DB / 6°C WB outdoor, air entering indoor at 20°C DB Nominal indoor airflow.

## CHARGING TABLE

Temp °C	Pressure KPa	Temp °C	Pressure KPa	Temp °C	Pressure KPa	Temp °C	Pressure KPa
-50	9	-19	320	11	1040	41	2439
-49	15	-18	336	12	1073	42	2500
-48	20	-17	353	13	1108	43	2564
-47	27	-16	369	14	1143	44	2628
-46	33	-15	387	15	1180	45	2694
-45	40	-14	405	16	1217	46	2760
-44	46	-13	424	17	1255	47	2829
-43	54	-12	442	18	1293	48	2898
-42	61	-11	462	19	1333	49	2969
-41	69	-10	481	20	1373	50	3040
-40	76	-9	502	21	1415	51	3114
-39	85	-8	523	22	1457	52	3187
-38	93	-7	545	23	1501	53	3264
-37	102	-6	567	24	1544	54	3340
-36	111	-5	590	25	1589	55	3419
-35	121	-4	613	26	1634	56	3498
-34	130	-3	637	27	1681	57	3580
-33	140	-2	661	28	1728	58	3662
-32	150	-1	687	29	1777	59	3747
-31	161	0	712	30	1826	60	3832
-30	172	1	739	31	1877	61	3920
-29	184	2	765	32	1928	62	4008
-28	195	3	793	33	1981	63	4099
-27	208	4	821	34	2034	64	4190
-26	220	5	851	35	2089	65	4284
-25	234	6	880	36	2144	66	4378
-24	247	7	911	37	2201	67	4476
-23	261	8	941	38	2258	68	4573
-22	275	9	974	39	2318	69	4675
-21	290	10	1006	40	2377	70	4776
-20	304						

## Fault Display Codes

### Outdoor Board Fault Display Codes

Display Code	Function / Fault
oFF	Unit Off or Unit Turning Off (flashing)
CooL	Unit Cooling Mode or Start Cooling (flashing)
HEAt	Unit Heating Mode or Start Heating (flashing)
dEF3	3 min to Defrost
dEF2	2 min to Defrost
dEF1	1 min to Defrost
dEF	Heating Mode - Defrost
HEAt	Heating Mode - Indoor coil pre-heat after defrost
oiLr	Oil Return Operation
dr-1	Demand Response Management 1 - Mode (Compressor Off)
dr-2	Demand Response Management 2 - Mode (System operation restricted to 50% of rated power)
dr-3	Demand Response Management 3 - Mode (System operation restricted to 75% of rated power)
ohP	Unit derating - Overheat Protection Mode
dtP	Unit derating - Discharge Temperature Protection Mode
cPP	Unit derating - Condenser Pressure Protection Mode
hSP	Unit derating - High Suction Pressure Protection Mode

ADC: Analog to Digital Converter  
 IGBT: Insulated-Gate Bipolar Transistor

DSP: Digital Signal Processor  
 PFC: Power Factor Correction

#### Reading the error code

Digit 1	Digit 2	Digit 3 + 4
Source	Circuit #	Error code

For Example:

Digit 1	Digit 2	Digit 3 + 4	Error code	Error Description
A	1	06	A106	Discharge temperature high

Digit 1	Digit 2	Digit 3 + 4	Error Description
A = Outdoor unit	*1 = Circuit-1 **2 = Circuit-2	06	Discharge temperature high
		07	Coil sensor failure
		08	Discharge sensor fail
		09	LP switch open
		10	LP sensor fail
		11	HP switch open
		12	HP sensor fail
		13	VSD fault
		18	Suction temperature sensor fail
		22	Ambient Sensor Fail
	50	Configuration error	
B = Indoor unit	1* / 2**	01	Phase failure (3-phase devices) or line undervoltage (single-phase devices)
		03	Output stage overheated
		04	Modbus Communication Error
		05	Fan Error
C = Compressor Envelope	1* / 2**	01	Outside envelope, area A
		02	Outside envelope, area B
		03	Outside envelope, area C
		04	Outside envelope, area D
		10	OHP Trip

Digit 1	Digit 2	Digit 3 + 4	Error Description
d = Drive	1* / 2**	01	Compressor Phase Overcurrent
		02	AC Input Overcurrent
		03	DC bus overvoltage
		04	DC bus undervoltage
		05	AC input overvoltage
		06	AC input undervoltage
		07	AC voltage imbalance
		08	Inverter desaturation
		09	HP Switch open
		12	Power module over temperature
		13	PFC igbt over temperature
		14	Lost rotor position
		15	Motor thermistor fault
		16	Precharge relay open
		17	DC voltage low
		18	Compressor phase over current intermediate
		19	Compressor phase current foldback
		20	Power module temperature foldback timeout
		21	AC input current foldback timeout
		23	Modbus communication lost
		24	Auto config communication fail
		25	DLT over temperature
		26	Motor temperature high
		27	Board temperature high
		28	Power module temperature high
		29	PFC IGBT temperature high
		30	DSP PFC Communication lost
		31	DSP communication lost
		32	Compressor phase current imbalance
		33	Three phase PFC current imbalance
		34	Micro electronics fault
		35	Motor overspeed
		37	HP transducer fault
		38	Compressor model config error
39	HP Sensor type config error		
49	PFC temperature imbalance		
50	DLT low temperature		
51	Motor temperature low		
52	Power module temperature low		
53	PFC IGBT temperature low		
54	Communication ADC failure		
62	Fault limit lockout		
E = Outdoor fan F = Indoor fan	1* / 2**	01	Phase failure (3-phase devices) or line undervoltage (single-phase devices)
		03	Output stage overheated
		04	Modbus Communication Error
		05	Fan Error
		06	Motor overheated
		07	Hall sensor error
		08	Motor blocked
		09	Speed limit exceeded
		11	Rotor position sensor calibration error
		13	DC-link undervoltage

Digit 1	Digit 2	Digit 3 + 4	Error Description
H Communication	1* / 2**	15	VSD Communication
		51	IDU Communication
		52	WC Communication
		54	IDU Fan Communication
		55	ODU Communication
		56	Master WC Communication
		57	ODU Fan Communication



## Maintenance

### Maintenance Procedures

This section describes the procedures that must be performed as a part of normal maintenance program. Regular servicing of equipment by licensed technician is highly recommended. Regular servicing of your unit helps in maintaining its optimum performance and reliability. **The checklist and service periods provided on this manual are guides only, as some sites may require more frequent servicing.** Always disconnect electrical power to the unit before performing these procedures unless otherwise required. It is always a safe practice to observe all safety warnings and cautions when conducting maintenance tasks.



#### DANGER

##### Live Electrical Connections!

It may be necessary to work with live electrical components on certain maintenance tasks. Only licensed electricians and qualified technicians are allowed to perform these tasks.

##### Beware of Rotating Fan Blades!

Always make sure that all power supplied to the fans are turned Off and isolated.

Observe WH&S safety procedures, do not wear loose clothing and any jewellery when working near the fans.

Wear PPE whenever performing any maintenance procedures.

Observe all necessary procedures when working on a confined space.



#### WARNING

##### Hazardous Voltage!

Always make sure that all power supply, including remote controls, are disconnected before performing maintenance.

Observe proper LOCK-OUT/TAG-OUT procedures to ensure that power cannot be inadvertently energised. Failure to disconnect power before maintenance procedures can result in serious injury and/or death.

EC Motors are fitted with high power capacitors and can have dangerous residual voltages at motor terminals after power has been isolated. Wait at least 5 minutes after power isolation and test for any residual voltage before beginning service work.

### Annual Maintenance Checklists

- Perform general maintenance inspections.
- Perform scheduled start-up checks.
- Leak test refrigerant circuits.
- Inspect contacts of all contactors and relays. Replace all worn contacts as required.
- Inspect, clean and tighten all electrical connections.
- Check fans for balanced operation. Make sure that there are no loose screws / bolts, no fan blades interference and no damage to the fans and guards.
- Inspect the air filters, clean or replace as required.
- Clean and repaint any corroded panel section.
- Ensure no blockage of airflow through variable speed drive.

### Cleaning the Condenser Coils

Clean the coils at least once a year or more frequently if unit is located in a dusty and dirty environment, in order to maintain your system's proper operating performance. High discharge pressures are good indication that the coils need cleaning. When using detergent or solvents to clean the coils, follow the manufacturer's instructions to avoid potential damage to the coils and to the unit.

To clean the refrigerant coils, use a soft brush and water spray, such as garden hose or pressure washer with low pressure nozzle.

 **WARNING****Do Not Use High Alkaline Detergent!**

When using detergent for coil cleaning, ensure that the alkaline level is no higher than 8.5, which can cause corrosion damage to the coils.

 **DANGER****No Water into the Electrical Compartments!**

Ensure consideration is given to the possibility of water entering the electrical compartments during cleaning of the condenser coil.

**Coil Cleaning Procedures**

- Disconnect power to the unit.
- Remove the louvered panels from the unit to gain access to the air inlet side of the coils.
- Use a soft brush to remove loose dirt and debris from both sides of the coils.
- Straighten bent coil fins with fin comb.
- Prepare the detergent solutions according to the manufacturer's instructions.
- Spray solution at a 90° angle to the coils, keeping a minimum nozzle spray angle of 15°, with at least a 1800mm distance from the coils and 600 psi pressure.
- Spray leaving air side of the coils first then the air inlet side. Allow the solution to stand on the coils for five minutes.
- Rinse both sides of the coils with cool clean water.
- Inspect the coils, if they are still dirty, repeat the cleaning procedure.
- Clean and wipe dry the outer and inner sides of the unit, the refrigerating parts and other components.
- Ensure that the condensate drain lines are not blocked.
- Reinstall all unit panels, covers and guards.
- Restore electrical power to the unit.

## Maintenance Frequency Checklist

Regular servicing of equipment by a qualified technician is recommended every 12 months for residential applications and every quarter for commercial applications. Regular servicing of your unit helps in maintaining its optimum performance and reliability. **The following checklist and service periods are provided as a guide only, as some sites may require more frequent servicing.**

ELECTRICAL											
Parts	Service Period					Detail of Service Check	Service Methods				
	1 Mth	3 Mth	6 Mth	1 Yr	2 Yrs			3 Yrs	4 Yrs	5 Yrs	
Printed Circuit Boards				✓						Visual Inspection	Tighten Terminals as necessary on printed circuit boards
Electrical Connections				✓						Check all electrical terminals, mains, communications, etc	Re-tighten if loose.

INDOOR UNIT											
Parts	Service Period					Detail of Service Check	Service Methods				
	1 Mth	3 Mth	6 Mth	1 Yr	2 Yrs			3 Yrs	4 Yrs	5 Yrs	
Casing / Panels and Frames				✓						Visual check for damage, rust and dust accumulation.	For highly corrosive environment, wash panels quarterly with water and neutral detergent solution. Wax panels. Repair / re-paint where required.
Insulation				✓						Visual check for insulation conditions.	Repair / replace insulation material.
Fan				✓						Visual check for run out of balance and dust attached	Clean off dust as necessary to negate possibility of fan running out of balance
Motor				✓ Ω						Visual check on wiring. Insulation resistance check to be carried out annually	Measure insulation resistance. Reading should be more than 1MΩ.
Heat Exchanger				✓						Check for clogging by dust. Check for leaks / damage.	Clean air inlet side as necessary. Straighten any bent fins using fins comb.
Drain Pan/ Condensation line				✓						Check for obstructions and free flow of water	Clean to eliminate obstructions/ sludge and check condition of pan. Pour water to ensure flow
Filter*		✓								Check for clogging by dust.	Clean Filter
Temperature Readings				✓						Measure air on and air off	Place temperature probe in return and supply air of unit.
Damper Motors (if fitted)				✓						Visual inspection of motors open/closing. Ensure no obstructions	Drive motors opened and closed. Ensure correct operation
Duct Works				✓						Inspect duct works for air gaps.	Re-tape any loose ducts.

\* Service period for filter cleaning may vary depending on operating time and surrounding environment.

OUTDOOR UNIT										Detail of Service Check	Service Methods
Parts	Service Period										
	1 Mth	3 Mth	6 Mth	1 Yr	2 Yrs	3 Yrs	4 Yrs	5 Yrs			
<b>Casing / Panels and Frames</b>				✓						Visual check for damage, rust and dust accumulation.	For highly corrosive environment, wash panels quarterly with water and neutral detergent solution. Wax panels. Repair / re-paint where required.
<b>Insulation</b>				✓						Visual check for insulation conditions.	Repair / replace insulation material.
<b>Fan</b>				✓						Visual check for run out of balance and dust attached	Clean off dust as necessary to negate possibility of fan running out of balance
<b>Motor</b>				✓ Ω						Visual check on wiring. Insulation resistance check to be carried out annually	Measure insulation resistance. Should be more than 1MΩ
<b>Heat Exchanger</b>				✓						Check for clogging by dust. Check for leaks / damage.	Clean air inlet side as necessary. Straighten any bent fins using fins comb.
<b>Condensate Drain Line (if available)</b>				✓						Check for obstructions and free flow of water	Clean to eliminate obstructions/ sludge and check condition of drain line. Pour water to ensure free flow.
<b>Compressor</b>				✓ Ω						Check for high / low pressure. Measure insulation resistance. Check compressor for abnormal noise/vibrations	Measure insulation resistance. Should be more than 1MΩ.
<b>Refrigeration Operational Readings</b>				✓						Make note of operational reading in test cool/heat	Check operating pressures, record superheat and subcooling values
<b>Safety Devices</b>				✓						Check calibration of safety devices such as HP and LP controls, sensors, etc	Check resistance of sensors, pressure cut in / cut out of pressure controls
<b>Faults</b>				✓						Check for any previous fault history on unit.	Investigate any causes for previous faults, reset fault history.

**Start Up and Commissioning Report**

INSTALLATION INFORMATION		
CUSTOMER	Name:	Tel. Number:
	Address:	
INSTALLER	Name:	Tel. Number:
	Address:	
Site Address:		Date Installed:
Model:		Serial Number:

CIRCUIT TEMPERATURE SETTINGS		
Supply Air Temperature		°C
Return Air Temperature		°C
Suction Temperature		°C
Discharge Temperature		°C
Condenser Coil Temperature		°C
Ambient Temperature		°C

INDOOR FAN SETTINGS		OUTDOOR FAN SETTINGS	
Indoor Fan Current	Amps	Outdoor Fan Current	Amps
Indoor Fan Airflow	l / s		
Indoor Fan PWM	%		
Set Static	Pa		

Check No Active Error Codes on the Unit	Checked:	<input type="checkbox"/>
---	----------	--------------------------

Date Checked:	
---------------	--

## Version History

DOCUMENT VERSION	BOM VERSION	UPDATE HISTORY
Ver 1	-0100	Released
Ver 2	-0100	Updated PKV850T Weight
Ver 3	-0100	Updated menu tree in the Configuring and Commissioning Setup.
Ver 4	-0100	Included Neo Wall Controller Options & PKV720T Weight.

