

ActronAir Easyconnect

Installation and Setup Guide for UltraSlim Ducted, Bulkhead Ducted and Cassette Systems



easyconnect

Compatible with:			
UltraSlim	Cassette	Mini Cassette	Bulkhead
LRE-071AS	CRE-053AS	MRE-035AS	BRE-026BS
LRE-100AS	CRE-071AS	MRE-050AS	BRE-035BS
LRE-130AS	CRE-100AS	MRE-035CS	BRE-052BS
LRE-170AS	CRE-125AS	MRE-053CS	BRE-071BS
LRE-071CS	CRE-140AS		BRE-026CS
LRE-100CS	CRE-100CS		BRE-035CS
LRE-125CS	CRE-125CS		BRE-050CS
LRE-140CS	CRE-140CS		BRE-070CS
LRE-170CS			

IMPORTANT NOTE:

Please read this manual carefully before installing or operating your air conditioning unit.



Table of Contents

01. Specification and Precautions	3
02. Components	4
03. Installation	5
04. Download and Install the Easyconnect App	10
05. Create an Account.....	10
06. Device Configuration	12
06.01. Amazon Alexa	12
06.02. Google Home	14
06.03. Smart Device (Easyconnect)	16
07. Operation and Control	21
07.01. Amazon Alexa	21
07.02. Google Home	22
07.03. Smart Device (Easyconnect)	24
08. Operating Functions	25
Appendix A.....	26

01. Specification and Precautions

Model: WUK-CAC1 (CAC#WF-60A1)

Standard: IEEE 802.11b/g/n

Antenna Type: External omnidirectional Antenna

Frequency: Wi-Fi 2.4G

Maximum Transmitted Power: 15dBm Max

Operation Temperature: 0 °C ~45 °C

Operation Humidity: 10%~85%

Power Input: DC 5V/300mA

Applicable system: iOS, Android

NOTE

Easyconnect App will require software updates from time to time to ensure compatibility with the latest Android and iOS operating versions. ActronAir will ensure updates are made quickly but will ultimately not be responsible for any issues relating to Android and iOS operating systems.









Wireless safety strategy:

Smart kit only supports WPA-PSK/WPA2-PSK encryption and non encryption. WPA-PSK/WPA2-PSK encryption is recommended.

NOTES

- The Smart phone camera needs to be 5 megapixels or more to scan the QR code.
- Network encryption may need to be reconfigured, when necessary, to ensure connectivity.
- Where issues in connectivity arise from the wireless network, there may be some differences in the display between the Easyconnect App and connected controllers.
- ActronAir will not be liable for any issues and problems caused by network connections, Wi-Fi router and smart devices. Please contact the product supplier of these third party devices directly to get further assistance.

02. Components

Name	Shape	Quantity
Smart Port Receiver and CN2 Cable		1
Extension Cable (6m)		1
4 Core Wire Control Cable		1
Disposable Remote Controller (Easyconnect setup only)		1
Easyconnect Wi-Fi USB		1
QR Label		1
Screw		3
Wall Mounting Plug		3
AAA Battery (1.5V)		2

03. Installation

Wi-Fi controller structure size figure:

(All dimensions are in mm unless specified).

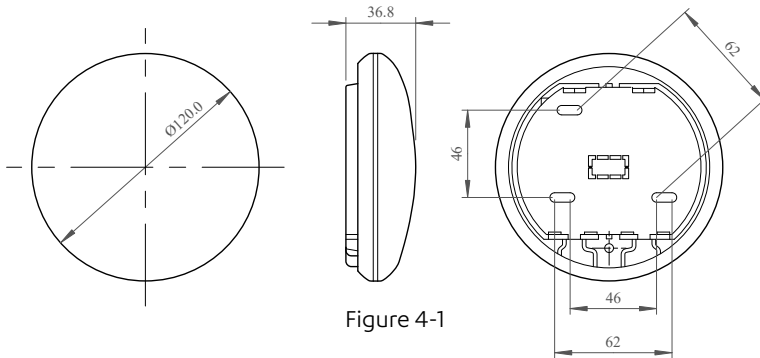

Figure 4-1

Do not exceed supplied cable lengths between indoor unit and smart port. Extension of this length may create loss of communication between the PCB and/or wired control Wi-Fi Smart Port. We recommend the following wired controller cable length maximums:

Wiring Specifications		
Wiring type	Size	Total Length
Shielded PVC or Cable	0.75mm ²	≤ 20m
	1.5mm ²	≤ 50m

NOTE

In order to avoid potential interference, it is recommended that the Wi-Fi Smart Port is mounted inside the living space, as close to the internet router as is practical. It is not recommended to install the Smart Port inside the wall cavity or roof space. If possible, avoid items which can cause potential interference in direct line between the modem and the Smart Port.

1. Remove the backing plate from the Smart Port Receiver.

Insert a screwdriver into the two slots in the lower part of the Smart Port Receiver and remove the backing plate. (See Figure 4-2)

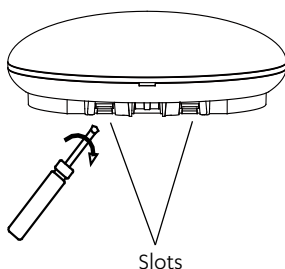

Figure 4-2

2. Mount the backing plate of the Smart Port Receiver inside the conditioned area, on the wall or ceiling, as close to the Wi-Fi router as is practical , using the three screws (M4x20) provided. (See Figure 4-3)

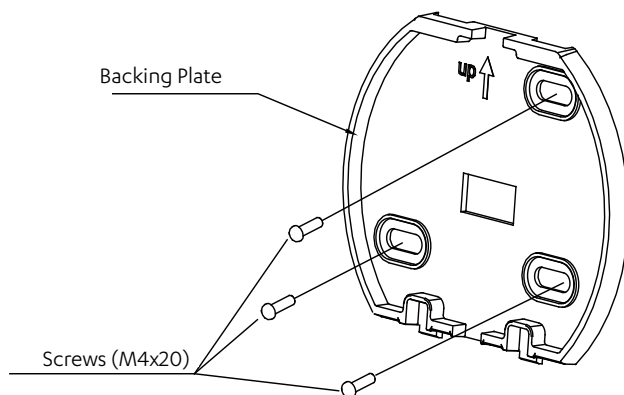

Figure 4-3

3. Insert the supplied Easyconnect Wi-Fi USB into the port at the back of the Smart Port Receiver. (See Figure 4-4)

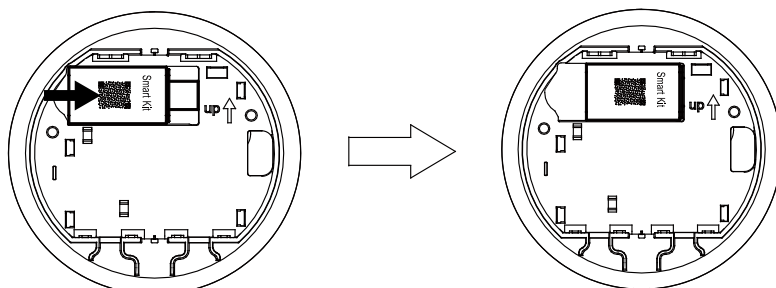

Figure 4-4

4. Connect the Smart Port:
There are two ways to connect the Smart Port to the air conditioning unit.

- **Connection to indoor unit and wired controller**

Remove the top cover as shown in Figure 4-5 and Figure 4-6. Use the wired control cable (supplied) to connect the wired controller and CN3 of the Smart Port. (See Figure 4-7). Use the extension cable (supplied) to connect the Smart Port Receiver from the CN2 port to the indoor PCB CN40 port.

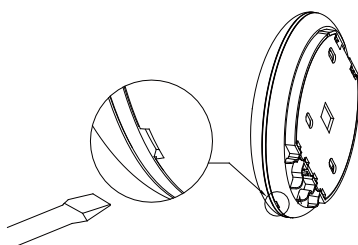

Figure 4-5

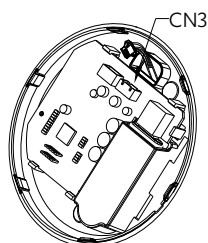

Figure 4-6

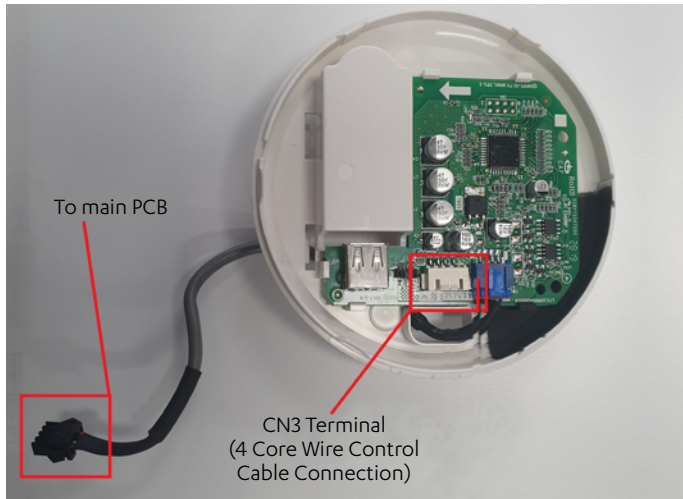

Figure 4-7

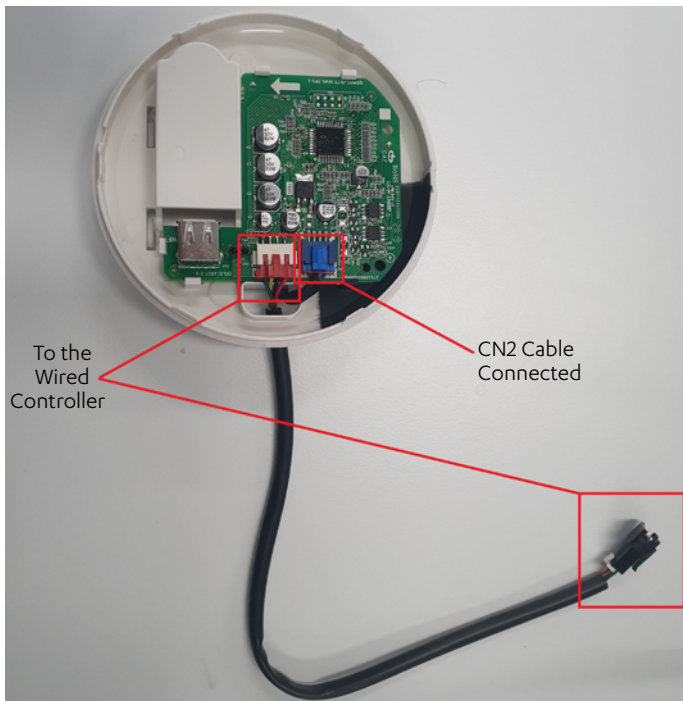
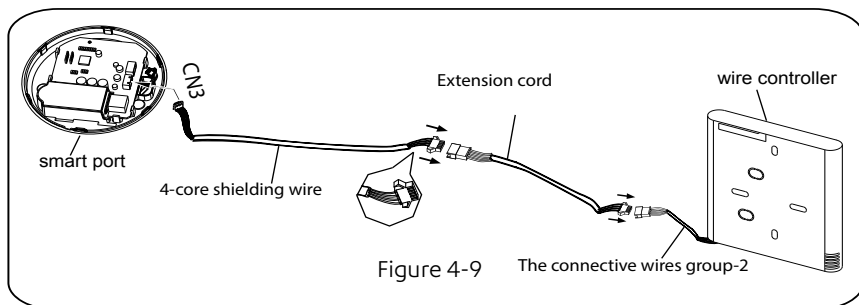
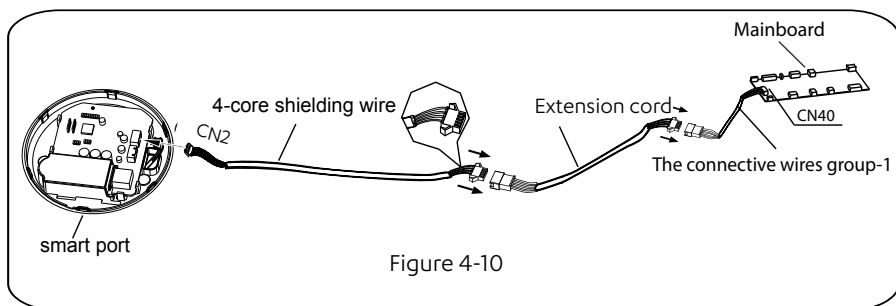

Figure 4-8



- **Connection to indoor unit with no wired connection.**

Run the 6m Extension Cable (Supplied) from the Smart Port Receiver CN2 connector to the indoor pcb terminal CN40. See Figure 4-10. This is the required method of installation if using exclusively with Wi-Fi or if using with a remote controller.



5. Reattach the upper part to the PCB backing cover.

Buckle the upper case after adjusting it, to avoid clamping the wiring during installation and clip it into place onto the backing plate mounted on the wall or ceiling. (See Figure 4-11)

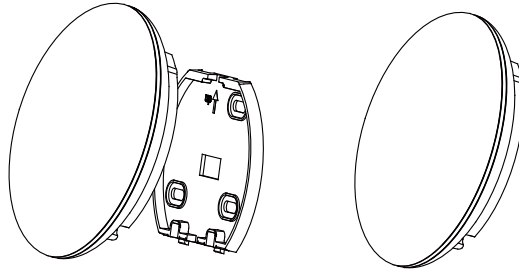

Figure 4-11

04. Download and Install the Easyconnect App

Search Easyconnect on your compatible mobile phone, tap download and then open the app to create a new account. (Refer to Section 05, for new account setup)



easy
connect



05. Create an Account

- Please ensure that you have a secure and operational internet connection readily available for the creation of your account and system setup.
- You will also require an active e-mail address which will be used as your username when creating an account, logging into and using the Easyconnect app.

1. When the app is opened for the first time, it will ask permission for sending notifications. It is the discretion of the user to allow or disallow the permission. The user can change this permission at any time in the phone's settings.

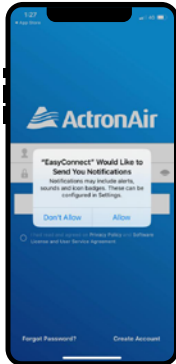

2. Tap on **Create Account**.



3. Enter your e-mail address, create and confirm a unique password, confirm the terms and conditions and tap on **Registration**.

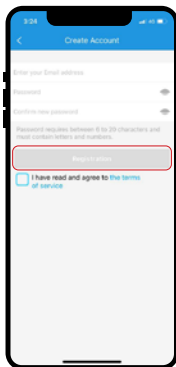

4. Once you have successfully registered with the app, it will prompt you to activate your account by clicking the link in your registered email address.

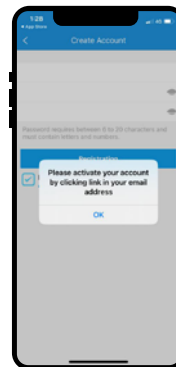

NOTE

- Please check your email for an email from **iot1@annto.com** titled "Hi, please activate your account to complete the registration".
- If you do not see the email in a few minutes, check your **"junk or spam"** folder.
- Activation time is sensitive and the account will need to be activated within the first 5 minutes of completing the registration.

06. Device Configuration

06.01. Amazon Alexa

1. Download Amazon Alexa from google playstore or apple if you haven't done so already. Once logged in, follow below steps



3. On this new screen, click on "Skills & Games" which will take you to a new search screen

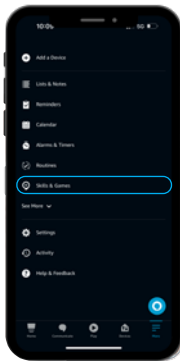

2. Once the Amazon Alexa app has been installed on your device, open up the app. Click on the "More" button which is positioned at the bottom right hand side of the screen. When you click "More" this will take you to a new screen.

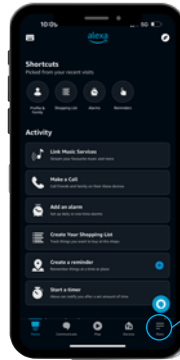

Click Here

4. Tap on the search tool on the top right hand corner.



Click Here

Installation Guide

Easyconnect App

5. Search for “easyconnect” skill.



6. Select Easyconnect” from the results list.

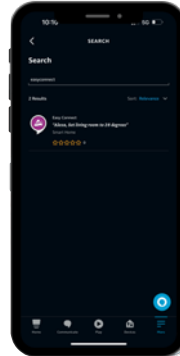

7. Once you have selected EasyConnect from the results list, click on “Enable to Use” button which will take you to the next step.



8. A login prompt for easyconnect will appear, login with your Easyconnect app credentials.

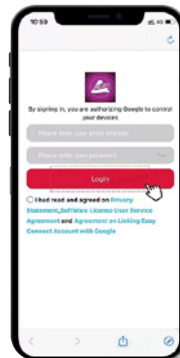

9. Once logged in, the Amazon Alexa App will confirm the successful linking of your account. You can now close this window by clicking on “Done” on the top left hand corner.
10. Alexa will then start looking for devices to connect with.

Click Here

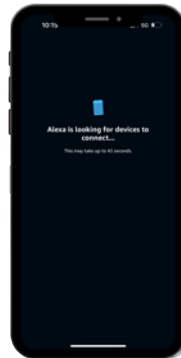
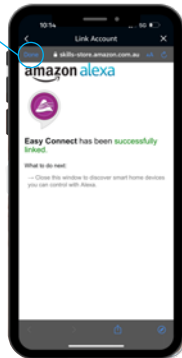

06.02. Google Home

1. Download the latest version of Easyconnect App and add the smart device.
2. Download and open Google Home App, tap “Set up device”-
3. Select “Works with Google”, and enter to search “easyconnect”.

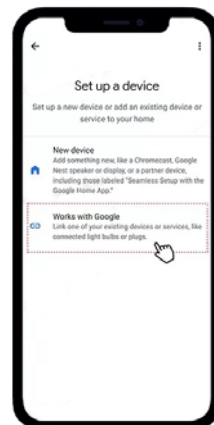
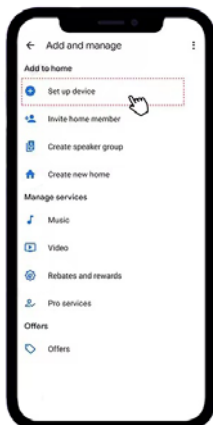

4. Choose “easyconnect” and jump to the authorisation page of Easyconnect App.

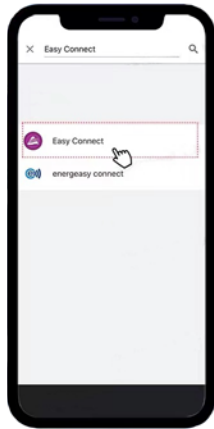

5. After logging in to your Easyconnect account, tap “Agree and Link”.

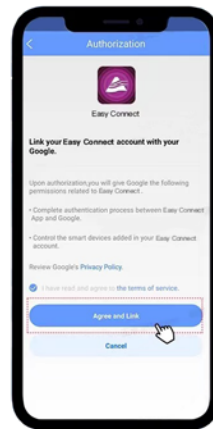

5. You will be redirected to Google Home App and the device will be shown.

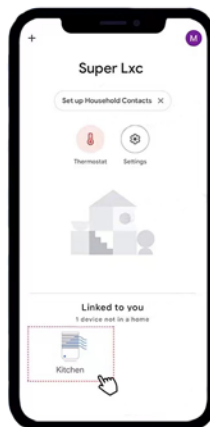

Now you can use Google Home voice controller to control your devices.

06.03. Smart Device (Easyconnect)

NOTES

- Ensure that the Android or iOS device can be automatically connected to the Wi-Fi network - you can adjust this in your phone settings.
- To configure Easyconnect, a wireless remote controller must be used - a disposable control is supplied in the kit to setup the Wi-Fi.

There are two ways to configure the network connection. This may be done via Bluetooth, scanning for available devices or by manual selection of the device.

06.03.01. Bluetooth Scanning

Ensure that Bluetooth on the mobile device is ON

1. Tap on **+ Add Device.**

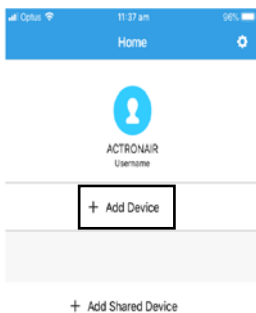

2. Power the Air conditioner off from the power supply for 15 seconds, then back on again.

3. Within 8 minutes of power being reset, press the LED button on the remote control 7 times (within 10 seconds) - this will initiate access point mode and allow your phone to link with the Easyconnect app setup process.

4. Tap on **Scan for nearby devices.**

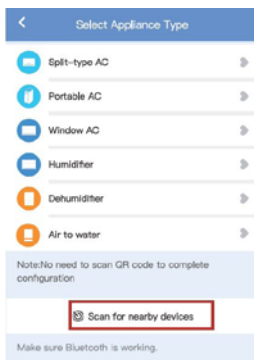

5. Wait smart devices to find, then click to add it.

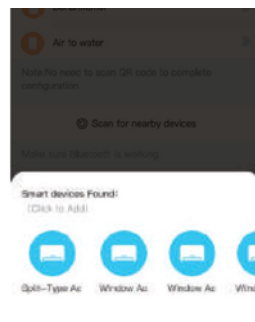

Note: If no device is found, go straight to manual configuration Section 06.02, step 2.

6. Select home Wi-Fi, enter the password.

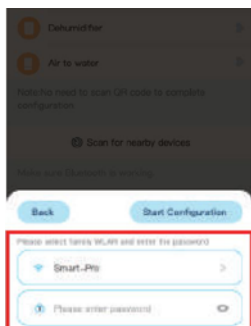

8. Device successfully detected. You can modify the default name.

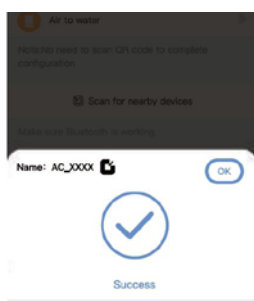

7. Wait to connect to the network.

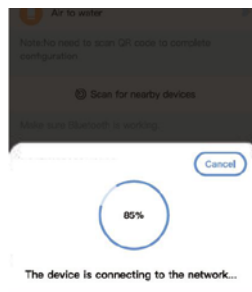

9. You can choose an existing name or customize a new name.

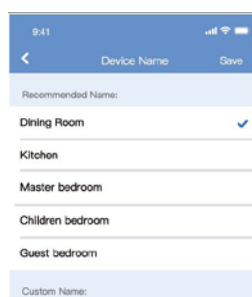

06.03.02. Manual Selection of Device

1. Tap on + Add Device.

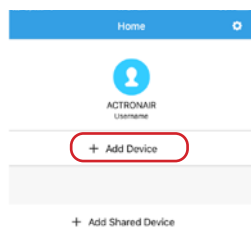

2. Tap the **Cassette/Duct** option.



3. Power the Air conditioner off from the power supply for 15 seconds, then back on again.

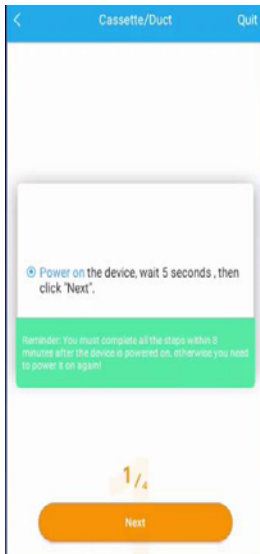

4. Within 8 minutes of power being reset, press the LED button on the remote control 7 times - this will initiate access point mode and allow your phone to link with the Easyconnect app setup process. Ensure the remote control is pointed at the appropriate receiver:
 - Cassettes (CRE) – Receiver on the indoor unit fascia.
 - Ducted (LRE/BRE) – Receiver on the Smart Port .

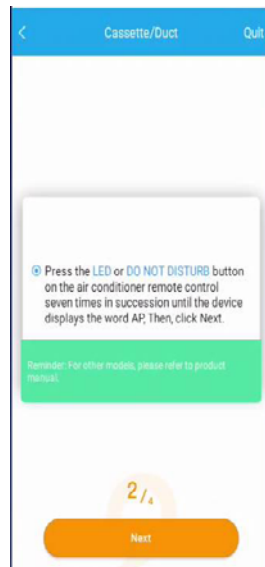

NOTE

Access Point mode is indicated by the white LED on the smart port flashing.

5. The next step will direct you to connect your network - link to: net_ac_xxxx
Default password is "12345678".

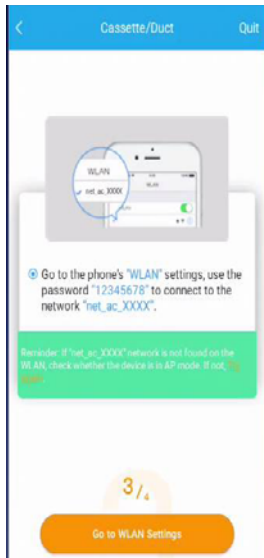

NOTE

Android devices will allow you to scan the QR code provided with the Easyconnect module, this will bypass the manual setup - allowing for quicker configuration. For android configuration using QR scanner, please refer to images below.

6. You can either scan the QR code or do manual setup.

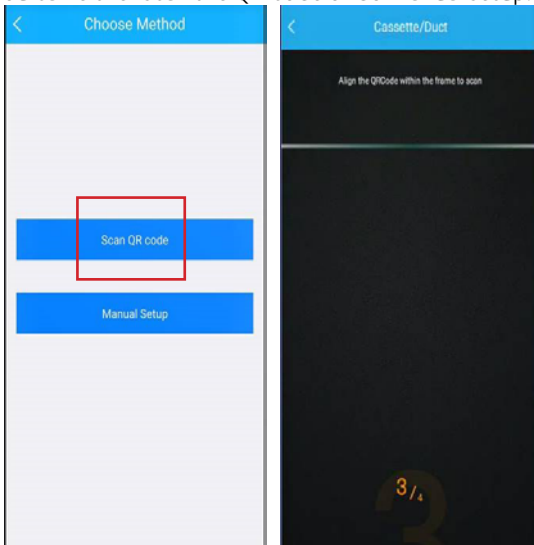

7. Select your Wi-Fi name (SSID) and enter your router password to commence configuration.

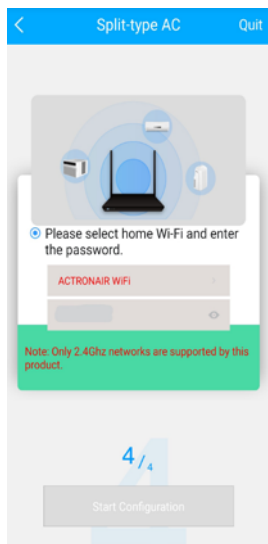

8. When a Wi-Fi connection has been established between Easyconnect and the network - automatic setup will begin.

- Once network configuration is successful, a success message notification will appear on the display screen.
- If the device status displayed is offline, refresh the device list by swiping down and releasing the screen.

Alternatively, turn off the unit and turn it on again.



07. Operation and Control

07.01. Amazon Alexa

SUPPORTED VOICE COMMANDS

Please use the name of your Air Conditioner as <device>.

Function	Utterance
Power On	"Alexa, turn <device> on."
Power Off	"Alexa, turn <device> off."
Report power state	"Alexa, is <device> powered on?"
Mode Auto	"Alexa, set <device> to auto."
Mode Cool	"Alexa, set <device> to cool."
Mode Heat	"Alexa, set <device> to heat."
Mode Fan	"Alexa, set <device> thermostat to off."
Report mode	"Alexa, what is <device> mode?"
Increase temperature by one degree	"Alexa, make it warmer on <device>."
Decrease temperature by one degree	"Alexa, make it cooler on <device>."
Increase temperature	"Alexa, increase <device> by <temp>."
Decrease temperature	"Alexa, decrease <device> by <temp>."
Set temperature	"Alexa, set <device> to <temp>."
Report setpoints	"Alexa, what temperature is <device> set to?"
Fan Speed Low	"Alexa, set <device> to low speed."
Fan Speed Medium	"Alexa, set <device> to medium speed."
Fan Speed High	"Alexa, set <device> to high speed."
Fan Speed Auto ⁽¹⁾	"Alexa, set <device> to enhanced."
Report controller ambient temperature	"Alexa, what is the temperature on <device>?"
(1) When system is in Fan Mode, Alexa will report the Thermostat status is OFF.	

NOTE

Some features may not be available depending on the model. Please refer to the product catalogue for applicable features

07.02. Google Home**SUPPORTED VOICE COMMANDS**

Function	Utterance
Power On	<i>“Hey Google, turn on air conditioner”</i>
Power Off	<i>“Hey Google, turn off air conditioner”</i>
Report power state	<i>“Hey Google, is air conditioner powered on?”</i>
Mode Auto	<i>“Hey Google, set air conditioner to auto mode”</i>
Mode Cool	<i>“Hey Google, set air conditioner to cool mode”</i>
Mode Heat	<i>“Hey Google, set air conditioner to heat mode”</i>
Mode Fan	<i>“Hey Google, set air conditioner to fan mode”</i>
Report mode	<i>“Hey Google, what is air conditioner mode?”</i>
Increase temperature by one degree	<i>“Hey Google, make it warmer on air conditioner.”</i>
Decrease temperature by one degree	<i>“Hey Google, make it cooler on air conditioner.”</i>
Increase temperature	<i>“Hey Google, increase air conditioner temperature”</i>
Decrease temperature	<i>“Hey Google, decrease air conditioner temperature”</i>
Set temperature	<i>“Hey Google, set air conditioner to <temp> degrees”</i>
Report setpoints	<i>“Hey Google, what temperature is air conditioner set to?”</i>
Fan Speed Low	<i>“Hey Google, set air conditioner to low speed.”</i>

Function	Utterance
Fan Speed Medium	<i>“Hey Google, set air conditioner to medium speed.”</i>
Fan Speed High	<i>“Hey Google, set air conditioner to high speed.”</i>
Fan Speed Auto	<i>“Hey Google, set air conditioner to enhanced.”</i>
Report controller ambient temperature	<i>“Hey Google, what is the temperature on air conditioner?”</i>

NOTE

Some features may not be available depending on the model. Please refer to the product catalogue for applicable features

07.03. Smart Device (Easyconnect)

1. When opening the Easyconnect App, you are greeted with this login page.

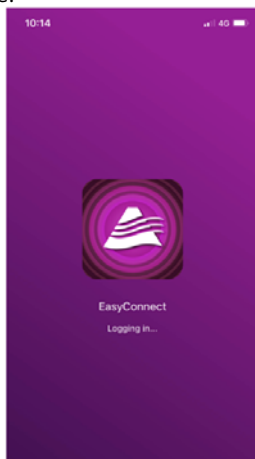

2. After a moment, you are taken to your account screen, which will have your linked air conditioners. Multiple air conditioners can be controlled from the one account.

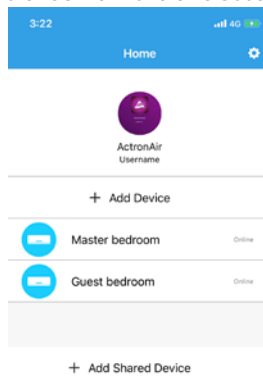

3. Select an air conditioner to turn on and you are greeted with the standby page - press the power button to activate the air conditioner.



4. Once on, you can control all available options for that air conditioner, to control others, you must go back to the main screen and activate them separately.

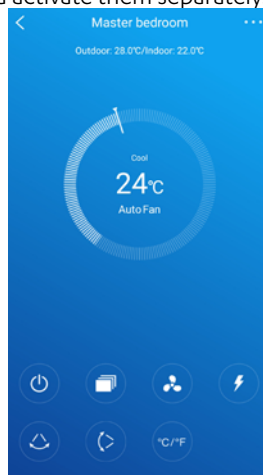

08. Operating Functions

Clickwheel

Use the clickwheel to adjust the system set temperature up/down.

Vertical Swing

Turns On/Off vertical louvre.

Horizontal Swing

Turns On/Off horizontal louvre.

Turbo

Sets turbo mode On/Off by pressing the lightning symbol when operating in heat and cool modes.

Sleep Mode

8 hour customisable sleep setting depending on the user's comfort.

Check System

Run the system through a diagnostic test to check more than 100 system parameters.

Share Device (via Easyconnect app on mobile devices)

Share access to air conditioner control, by sharing the QR code on each mobile device so that all family members can have easy access to the control of the air conditioner.

Timer On/Off

Operating on a 12/24 clock depending on user preference.

Follow Me

Enables the remote control to measure the room temperature at its current location and sends a signal back to the unit at 3-minute intervals.

Note: If a bulkhead unit is connected, the temperature value displayed is taken from the indoor unit sensor, the **Follow Me** value will not be displayed.

Appendix A

Receiver Board for Ducted Units:

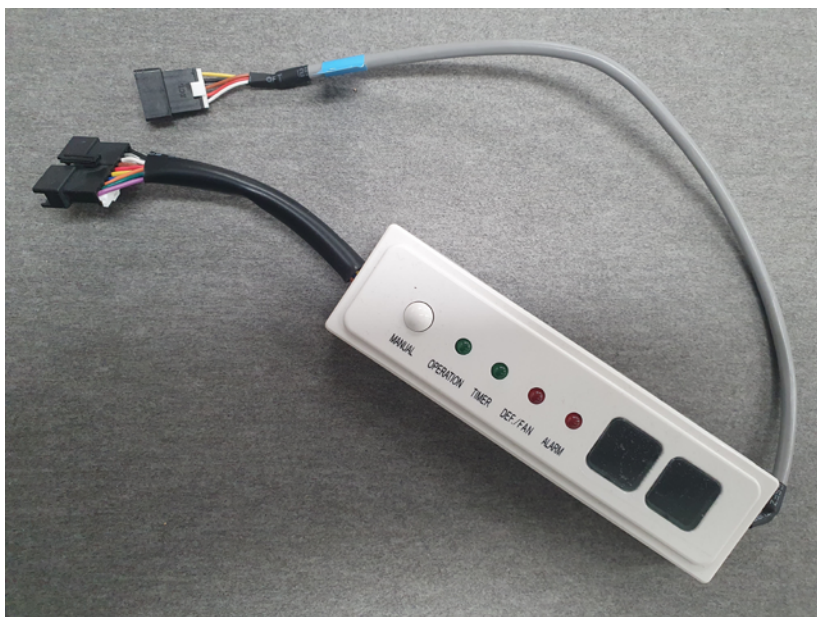

THIS PAGE WAS INTENTIONALLY LEFT BLANK



©Copyright 2020 Actron Engineering Pty Limited ABN 34 002767240. ®Registered Trade Marks of Actron Engineering Pty Limited. ActronAir is constantly seeking ways to improve the design of its products. Therefore, specifications are subject to change without notice.

Installation Guide - Easyconnect App
Document: 9590-4009 **Ver. 6 230501**