

# WALL CONTROLLER

## Installation Instructions



### Controller Model Number

LR7-1W

LR7-1G

#### **IMPORTANT NOTE:**

Please read this manual carefully before installing or operating your air conditioning unit.



## Table of Contents

<b>01. Safety Precautions .....</b>	<b>2</b>
<b>02. Specifications .....</b>	<b>2</b>
<b>03. Installation .....</b>	<b>3</b>
<b>04. Wiring Diagram.....</b>	<b>4</b>
04.01. Single Wall Control to Indoor Board .....	4
04.02. Multiple Wall Control .....	4
<b>05. Controller Assignment.....</b>	<b>5</b>
<b>06. Sensor Enable/Calibration.....</b>	<b>5</b>
<b>07. Enabling Zones and Assigning Sensors .....</b>	<b>6</b>
<b>08. Minimum and Maximum Zone Positions .....</b>	<b>6</b>
<b>09. Advance Series Self-Learn Mode (EVV Indoor Models) .....</b>	<b>7</b>
09.01. Initiating Self-Learn Mode .....	7

## 01. Safety Precautions

1. Read all instructions in this manual before operating the air conditioning unit. Failure to do so may result in damage to the unit and void your warranty.
2. Turn off the power supply to the unit and follow necessary LOCK-OUT/TAG-OUT (LOTO) procedures to ensure that power supply is not re-energised accidentally.
3. This control interface is connected to the wall control terminal block on the Indoor board via screwed terminals and Cat5e UTP (AWG24) Data Cable. Ensure that this unit is not installed on voltages other than specified.
4. Make sure that the unit installation complies with all relevant council regulations and building code standards. All electrical wiring must be in accordance with current electrical authority regulations and all wiring connections must follow the electrical diagram provided.
5. WH&S rules and regulations must be observed and will take precedence during installation process.
6. Only use this Control Interface with an ActronAir air conditioner as described in this installation guide.

## 02. Specifications

- Voltage: 12VDC +/- 10% (LR7 control connects directly to the Indoor board)
- Data: Cat5e UTP (AWG24) Data Cable, Maximum Cable Length up to 100m
- Operating conditions: -10 to 60°C, < 90% RH non-condensing
- Storage conditions: -20 to 70°C, < 90% RH non-condensing
- Dimensions - mm: 130 x 130 x 14.5 (W x H x D)

### NOTE

Do not use ActronAir 4 Core Data Cable Part Numbers: 4070-003/AMDC4 or Non-Twisted Pair multi core cable.

## 03. Installation

### 1. Remove back cover, as shown in the diagram below

- Insert and gently twist screwdriver into the slot at the top and the bottom of the Control Interface. Do this procedure alternately between the four slots until the back cover of the control separates.
- Use large enough flat blade screwdriver to fit into the slot in order to avoid damaging the Control Interface.

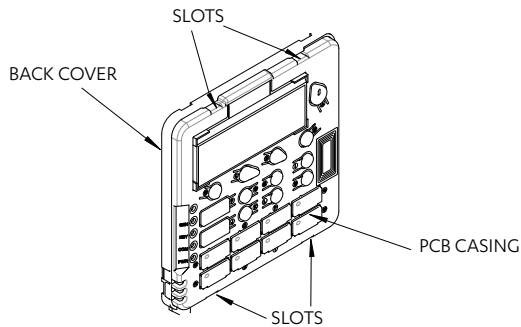

### 2. Mount back cover to the wall

- Mount the back cover to the wall with screws (not supplied) via screw holes. If required, the use of a plasterboard mounting bracket (not supplied) is recommended to mount the back cover to the wall.
- Ensure that the Control Interface back cover is aligned and leveled on the wall before tightening the screws.

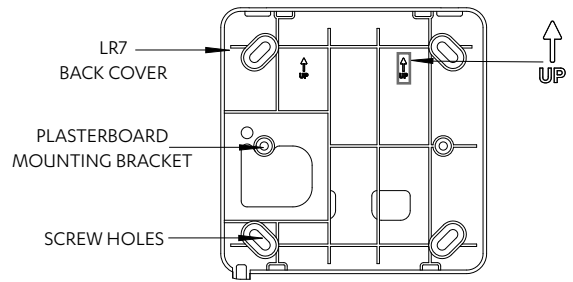

### 3. Connect wiring at the back of Control Interface

- Ensure that all wiring is tightly connected. All wiring must be in accordance with the provided wiring diagram.

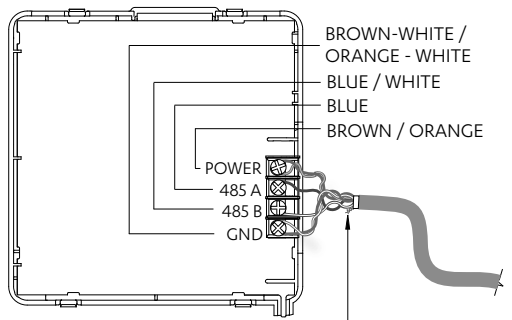

CUT OFF AND DO NOT CONNECT GREEN/GREEN-WHITE PAIR

#### WALL CONTROL WIRING

POWER: - BROWN / ORANGE  
 485 A: - BLUE  
 485 B: - BLUE-WHITE  
 GND: - BROWN-WHITE / ORANGE-WHITE  
 NOT USED: - GREEN / GREEN-WHITE

### 4. Attach PCB casing to the back cover

- Attach the PCB casing by aligning with the back cover mounted on the wall.
- Ensure the PCB casing makes a 'click' sound after mounting.

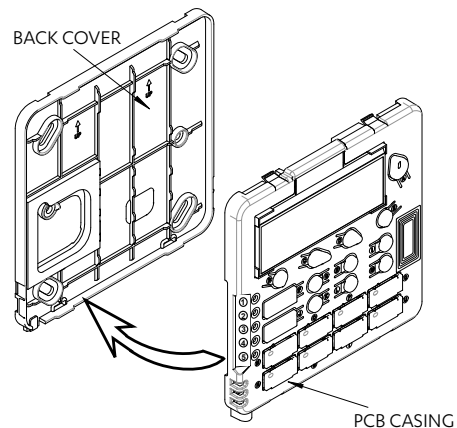

### 5. Select zone buttons

- Remove the relevant zone buttons for zone name to be allocated and attach to wall control.
- Ensure the buttons make a 'click' sound when attached to the PCB casing.

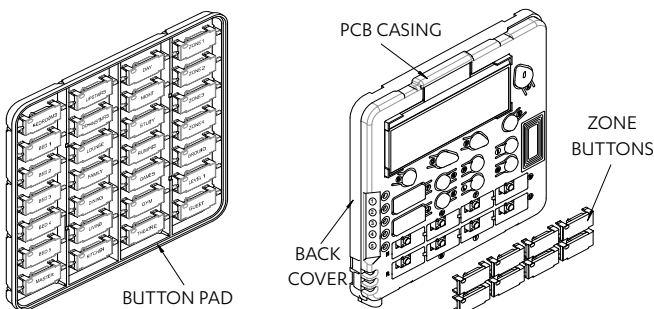

#### NOTE

Front cover can be removed even after installation. Press at the bottom of the control interface and pull the front cover.

### 6. Attach the front cover, as shown in the diagram below

#### IMPORTANT

Ensure protective film is removed from inside of the front cover before attaching.

- After attaching the front cover, check that the Control Interface is aligned and leveled on the wall.

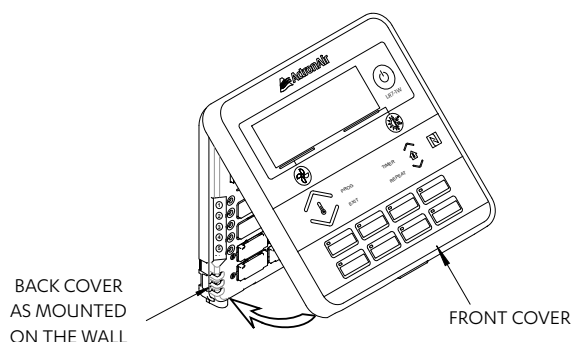

## 04. Wiring Diagram

### 04.01. Single Wall Control to Indoor Board

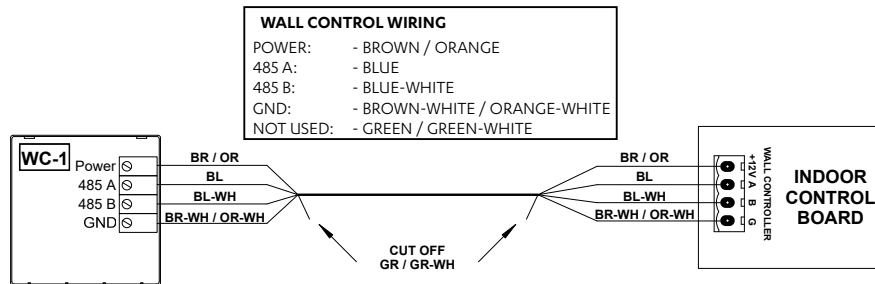

### 04.02. Multiple Wall Control

#### 04.02.01. Star Wall Control to Indoor Board

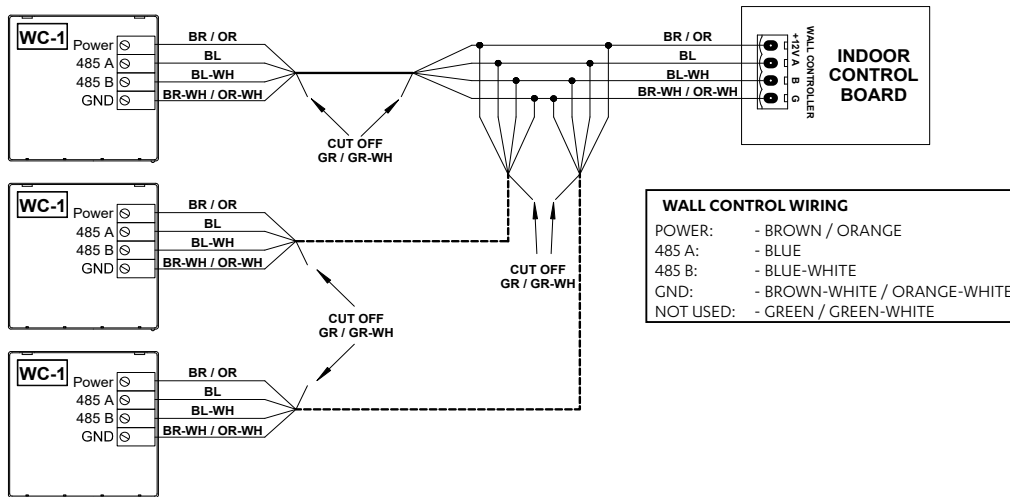

#### 04.02.02. Series Wall Control to Indoor board

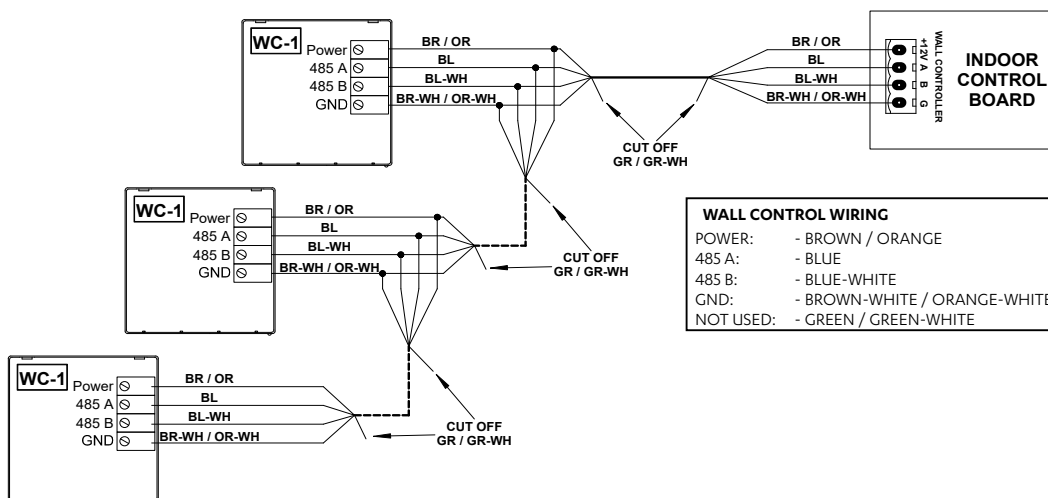



Item	Description	Maximum Cable Length
ID Control Bord to WC-1	Indoor PCB to Wall Controller 1	100 m
ID Control Bord to WC-2, ID Control Bord to WC-3	Indoor PCB to Wall Controller 3 (last controller)	75m (Daisy Chain)*

\*Maximum Daisy Chain connection is up to 2 Wall Controllers.

## 05. Controller Assignment

### NOTE

For installations where an LR7 is being installed with a Neo Wall Control, C-1 will always need to be assigned to the Neo Wall Control.

Upon initial start up of the system, all connected LR7 controls (up to 3) will display **C-0**. After 3 seconds, an auto assignment process will take place with the auto-assigned controller ID displayed on the screen **C-1**, **C-2** and **C-3**. The user can change the controller assignment between **C-1** and **C-3** with the  or  buttons. For the system to function correctly, a **C-1** controller must be present, with each controller requiring a unique controller assignment. The displayed text will remain on the controller until user acknowledges the assignment by pressing the **PROG** button to enter the Home Screen.



### NOTE

If the C-0 display did not change, check the wiring between the controller and Indoor Unit Board. This may be caused by:

- Loose or interchanged wire connection or (between Controller and Indoor Unit Board)
- No communication between the controller and Indoor Unit Board due to faulty cable

Upon subsequent power cycles, all controllers will show their controller ID for 3 seconds before proceeding to the Home Screen.

### Manual Controller Assignment

1. Press and hold the **REPEAT** and **TIMER** buttons for 3 seconds then release to enter Service Menu.
2. Press the **PROG** button to enter Service Menu 01.
3. Press the  or  buttons to select the appropriate controller assignment.
4. Press the **PROG** button to accept the selection.
5. Press the **EXIT** button once to return to Main Screen.

### NOTE

In the case of disconnecting the **C-1** controller from the system, the other LR7 controllers will show an error code (E56 - No main wall controller detected). To troubleshoot this error code:





- Troubleshoot **C-1** LR7 controller - check the wiring & connection of the controller. If E56 is still being displayed on **C-2** and **C-3**, connect a replacement LR7 controller. During its first power on cycle, it will auto assign itself to the vacant address.

## 06. Sensor Enable/Calibration



1. Press and hold the **REPEAT** and **TIMER** buttons for 3 seconds then release to enter Service Menu.
2. Press the  button to scroll through to Service Menu 02.
3. Press the **PROG** button to enter Service Menu 02.

### NOTE

The display will toggle between sensor name (**CS1** - Wall Control Sensor 1) and actual temperature reading. By default, all connected sensors are enabled, displayed **ON**, and have a calibration factor of 0. **CS1/CS2/CS3** represent wall controller sensors and **rs** represents remote sensor.

4. Press the  or  buttons to select the appropriate sensor to calibrate or turn **ON** or **OFF**.
5. Press the **PROG** button to enter Wall Control Sensor settings.
6. Press the  or  buttons to change the temperature offset of Wall control sensor.

### NOTE



Offset range is  $\pm 9$ , with 0.1 increments per  or  buttons press. The  button may be pressed to enable/disable sensor.

7. Press the **PROG** button to accept the changes.
8. Repeat steps 4-7 to enable/disable and calibrate all applicable sensors.
9. Press the **EXIT** button twice to return to Main Screen.

## 07. Enabling Zones and Assigning Sensors

**NOTE**





On initial power-up, an automatic zone detection takes place. If zones do not appear on the control upon commissioning, cycling power will enable another automatic zone detection.

1. Press and hold the **REPEAT** and **TIMER** buttons for 3 seconds then release to enter Service Menu. Press the  button to scroll through to Service Menu 14.
2. Press the **PROG** button to enter Service Menu 14. Press the  or  buttons to change the zone you wish to enable or the required zone button on zone pad. Display will show zone number, enabled **ON** or **OFF** and number of assigned sensors to that zone. Selected zone will also be indicated by the zone's LED on the zone pad.



**NOTE**

**ZONE 1** settings appear by default. Zone 1 is **ON** by default.



3. Press the **PROG** button to enter **ZONE 1** settings. Press the  or  buttons to toggle between **ON** and **OFF**. For this example, switch on **ZONE 1**.
4. Press the **PROG** button to assign a sensor to the selected zone. Press the  or  buttons to cycle through available sensors. For this example, select zone controller sensor **C - 1**.

**NOTE**

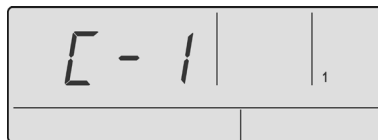

The sensors are determined by what appears on the display screen.

Controller Name	Description	Sensor Name	Description
C-1	Wall Control 1	RS1	Remote Sensor 1
C-2	Wall Control 2	RS2	Remote Sensor 2
C-3	Wall Control 3	RS3	Remote Sensor 3





5. Press the **PROG** button to select a second sensor. By default, the value is ---, indicating that there is no assigned second sensor. Press the  or  buttons to cycle through available sensors. If a second sensor is selected, the zone temperature will be averaged between the two sensors.
6. Press the **PROG** button to return to zone selection screen. Repeat steps 3-5 to configure zones. Press the **EXIT** button to return to Main Screen.

## 08. Minimum and Maximum Zone Positions



1. Press and hold the **REPEAT** and **TIMER** buttons for 3 seconds then release to enter Service Menu. Press the  button to scroll through to Service Menu 15.
2. Press the **PROG** button to enter Service Menu 15. Press the  or  buttons to change zones or press the required zone button on zone pad. Display will show zone number, enabled **ON** or **OFF** and number of assigned sensors to that zone. Selected zone will also be indicated by the zone's LED on the zone pad.



**NOTE**

**ZONE 1** settings appear by default. Detected Zones are **ON** by default.

3. Press the **PROG** button to enter the selected zone's settings. Display will show the zone **OPEN** percentage and **HIGH**. By default this will be 100. Press the  or  buttons to change value.

**NOTE**

**OPEN** and **HIGH** range is 5-100%, with 5% increments per the  or  buttons press.

- Press the **PROG** button to accept changes. Display will show the zone **CLOSE** percentage and **LOW**. By default this will be 0. Press the  or  buttons to change value.

**NOTE**

**CLOSED** and **LOW** range is 0-45%, with 5% increments per the  or  buttons press.

- Press the **PROG** button to accept changes and return to the zone selection screen. Press the **EXIT** button to return to Service Menu.



## 09. Advance Series Self-Learn Mode (EVV Indoor Models)

- Ensure all connected zones have been detected or enabled.
- Before activating, ensure the following:
  - Return air filter, box and grille are properly installed.
  - All doors or any other restrictions that may obstruct the air path back to the return and grille are open.
  - Adjustable outlets should be in open position and System Air Balance should be complete.

### 09.01. Initiating Self-Learn Mode

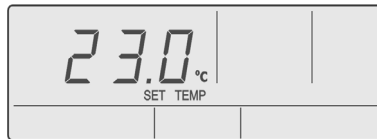
- System should be in the OFF MODE before activating self-learn mode.



- Press and hold the  button and  button for 5 seconds or until the word **Lrn** appears on the display and release.



- Press the  button once and release.
- AUTO** will flash on the controller display during programming of self-learn mode.



**NOTES**

- If a self-learn passes **PAS** will display on the wall controller.

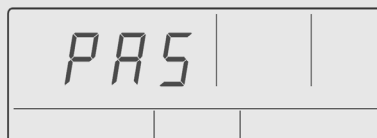

- If a self-learn fails, **FAL** will display on the wall controller.

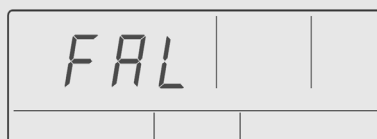

**Note:** Refer to Service Manual for troubleshooting.

- To return to Main Menu, press **EXIT**.
- To cancel Self-learn Mode, press  button or **EXIT**.

