

VRF BACNET

Operation Manual

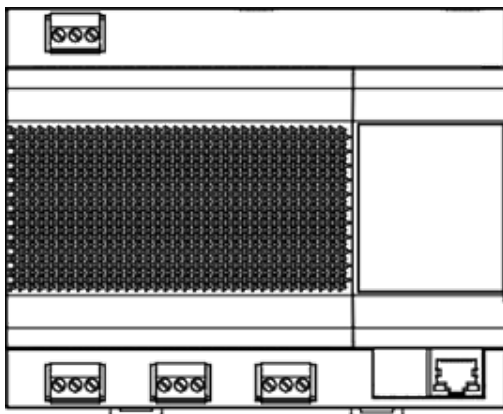

Model Numbers

MGW-BACCS

IMPORTANT NOTE:

Please read this manual carefully before installing or operating your air conditioning unit.



ActronAir

CONTENTS

1 Safety Precautions

- 1.1 Icon description 02

2 Product Description

- 2.1 Debugging for Use 05
- 2.2 BACnet 09
- 2.3 Web Functions 39

3 IP Address Resetting 47

4 Installation Instructions

- 4.1 Product Introduction 48
 - 4.2 Product Dimensions 48
 - 4.3 Installation Accessories 49
 - 4.4 Installation Method 49
-

1 Safety Precautions

The Installation & Owner's Manual of this product describes how to properly handle the product, prevent personal injury and property losses, as well as how to use the product correctly and safely. Read the following carefully, make sure you understand the content (symbols and marks), and observe the precautions below.

CAUTION

Read the safety warnings carefully prior to installation.

Be sure to observe the important safety precautions provided below.





Meanings of labels:

 **Warning** Indicates that improper handling may lead to personal injury or material loss.

 **Caution** Indicates that the operations will be affected due to ignoring a precaution.

After the installation is completed, confirm that no errors occur during the trial run, and hand over the manual to the customer for safekeeping.

1.1 Icon description

Icon	Name	
	Prohibited. Information about what is specifically prohibited is provided using graphs or texts in the icon or nearby.	
	Mandatory. A specific mandatory requirement is provided using graphs or texts in the icon or nearby.	
 Warning	Commissioned Installation	Ask your local dealer or professionals to install the product. Installation personnel must have relevant professional knowledge. Incorrect installation by non-professionals may lead to a fire, electric shock, or injury.
 Warning of Use	Prohibited	Do not use combustible paints to spray directly on the data converter as this may cause a fire.
	Prohibited	Do not handle the product with wet hands, and do not let water seep into the device. Otherwise, an electric shock may occur.

 **WARNING**

This unit must be installed by professional technicians. Users are not allowed to install the unit themselves; otherwise, personal injury or damage to the controller may occur.

Other electrical wiring work must be carried out by a professional technician according to the circuit diagram. All wiring work must comply with electrical safety specifications.

It is forbidden to modify the use and function of the product without authorization.

 **CAUTION**

Do not install the product in a location where flammable gas can easily leak. Any leakage within the vicinity of the device may cause a fire.

The wiring must be compatible with controller current.

Be sure to check the wiring before powering on the product. Never install the machine while the power is on.

In the event of any malfunction, please contact a professional technician. DO NOT disassemble or repair the unit without authorization.

This equipment is not suitable for places where children gather.

2 Product Description

MGW-BACCS Gateway (this Gateway) provides standard BACnet/IP services for VRF units.

It is suitable for all ECOFLEX series units, that is, ECOFLEX ODUs and ECOFLEX IDUs.

This Gateway supports 3 RS-485 buses and each bus is capable of connecting 8 ECOFLEX refrigerant systems (the maximum IDU quantity is 64).

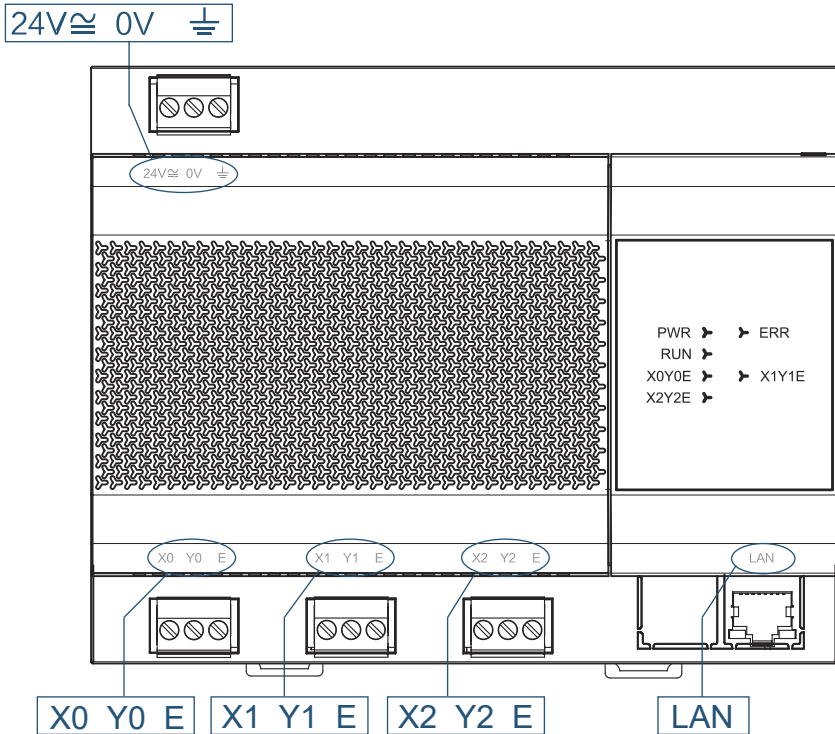

Port	Function
X0Y0E, X1Y1E, X2Y2E	Isolated RS-485 ports, each connecting to ECOFLEX VRF units in up to eight refrigerant systems (The maximum IDU quantity is 64.) (*1)
LAN	Provides the BACnet/IP protocols, and enables web page configuration (The computer and this Gateway need to be in the same network segment.)
24V 0V	24V AC/DC power supply

*1: The X port of the Gateway is connected to the X port of the ODU, and the Y port of the Gateway is connected to the Y port of the ODU. When multiple refrigerant systems are connected, they need to use different addresses.

Indicator	Item	Status	Description
PWR	Power supply	Off	The Gateway is powered off.
		Steady on	The Gateway is powered on.
RUN	Operating	Off/Steady on	The Gateway main program has not started, or a serious error has occurred.
		Blinking	The Gateway main program is functioning normally.
ERR	Fault	Off	No abnormalities
		Steady on	A Gateway sub program does not work due to an error.
X0Y0E	X0Y0E communication status	Off	No data transmitting
		Blinking	Data transmitting
X1Y1E	X1Y1E communication status	Off	No data transmitting
		Blinking	Data transmitting
X2Y2E	X2Y2E communication status	Off	No data transmitting
		Blinking	Data transmitting

Operating ambient temperature	-10 C~+50 C
Operating ambient humidity	RH25%~RH90%

2.1 Debugging for Use

When a third party needs to integrate the monitoring of VRF units on the Gateway, the following configuration may be required based on the actual project.

The default IP address of the Gateway is 192.168.1.8. In the address bar of the Chrome browser (*2), enter "https://Gateway IP address" to open the web page of the Gateway (*3).

Username: admin

Default password: 123AB@ab

Note: The password is case-sensitive.

*2: Other browsers may be incompatible, preventing the Web function from working properly.

*3:

1. The PC and the Gateway need to be in the same network segment. For specific settings, consult relevant IT personnel.
2. The PC OS can be Windows 7 (32-bit or 64-bit) or later versions.
3. The resolution of the PC cannot be lower than 1600 x 900.
4. Chrome browser needs to be in 70.0 or any later version.

If the PC IP address is, for example, 192.168.1.100 and you enter "https://192.168.1.8" in the address bar of the Chrome browser, the following page will be displayed:

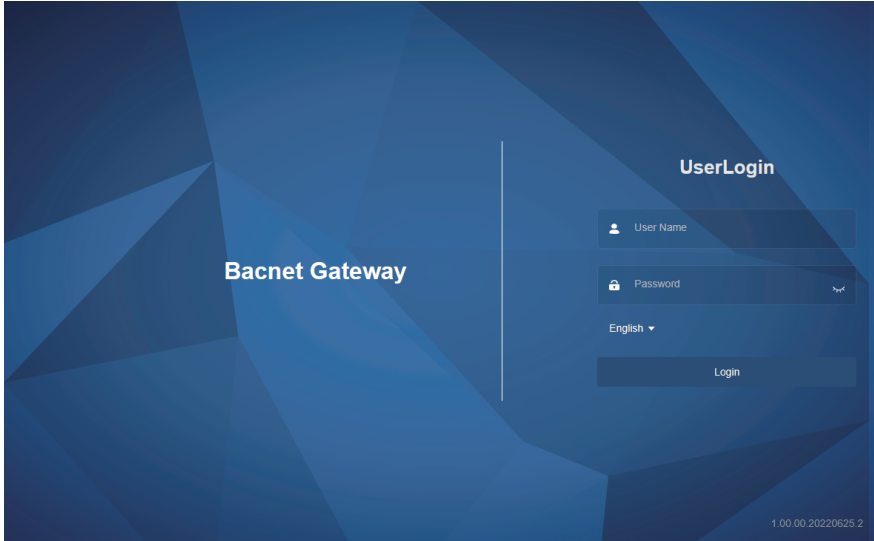

Click **English** to switch the language.

Note: The language selection uses your browser's cache. When the browser is changed or the browser cache is cleared, the default language is restored.

2.1.1 Configure IP and BACnet related information of the Gateway on the System Configuration page.

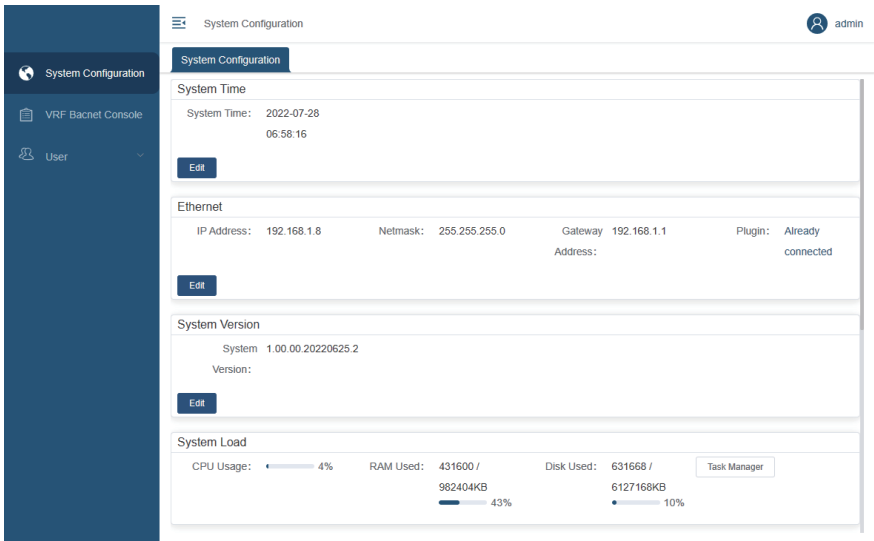

- 2.1.1.1 Open the System Configuration page, and click "Edit" in the **Ethernet** pane, and edit relevant parameters in the opened dialog box.
 The IP Address, Subnet Mask and Gateway Address need to be provided by the IT Administration of the network it is connecting to.

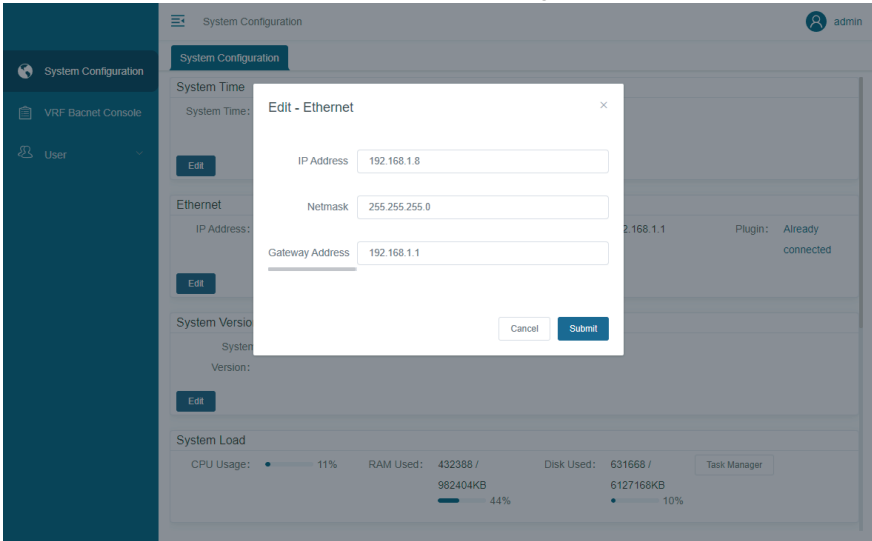

Note: After you change the IP address, this page will become unavailable, and you need to log in again by using the new IP address.

Ensure you change your PC IP Address to be the same as the new IP Address entered

Note: After changing the IP address, you are advised to restart the Gateway. Otherwise, some functions will be unavailable.

- 2.1.1.2 Open the **System Configuration** page, and click "Edit" in the **Bacnet Configuration** pane.



Bacnet Configuration: BACnet address (The default value is 19 and the value range is 2 to 400.)

BACNet Port: The default value is 47808 and the value range is 1 to 65534.

After the change, click "Submit" to save the configuration.

Debug Mode is enabled by default. When Debug Mode is enabled, you can check whether the BACnet function of the Gateway is normal on the VRF Bacnet Console page.

After the internal verification, be sure to disable Debug Mode.

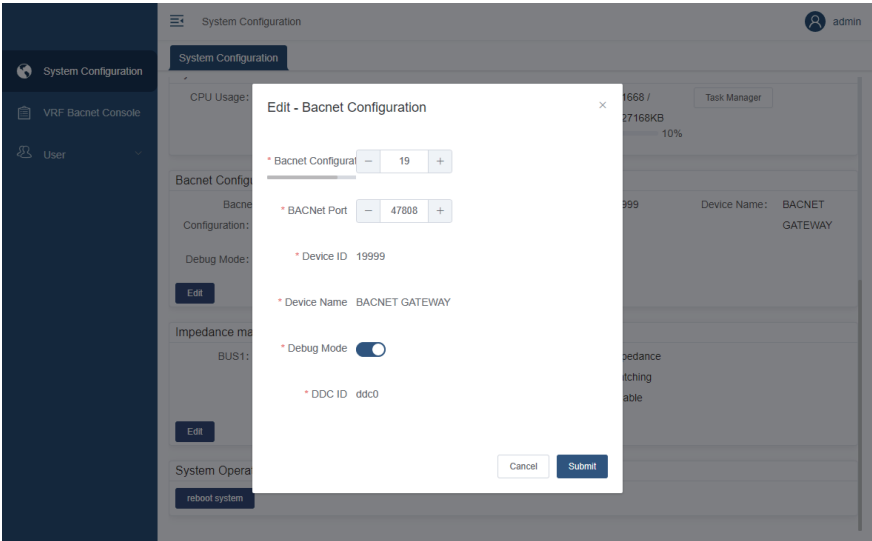

2.1.2 Check whether the BACnet function of the Gateway is normal on the **VRF Bacnet Console** page.

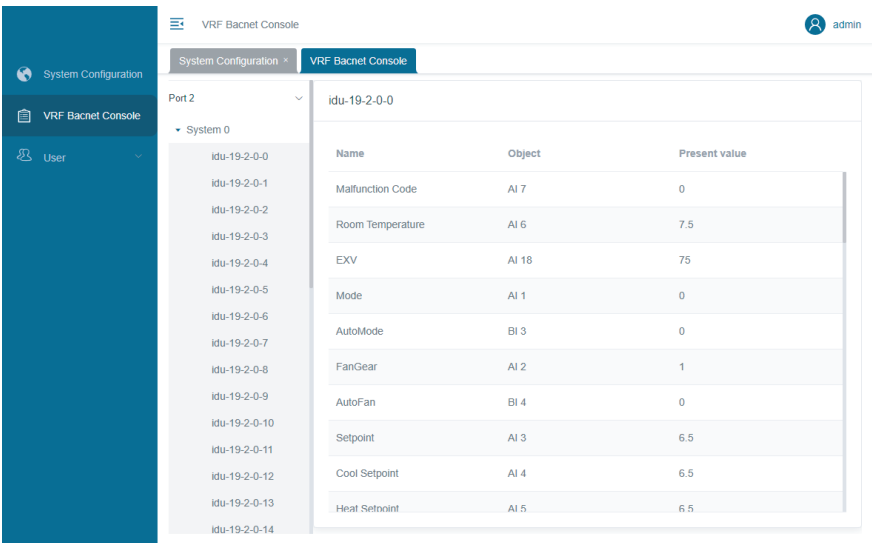

Port 0 is X0Y0E, Port 1 is X1Y1E, and Port 2 is X2Y2E.

As shown in the figure above, when you click an item in the left list, such as idu-19-2-0-0, the right pane will display the corresponding BACnet parameter values. If the values are displayed, the BACnet function is normal.

2.2 BACnet

2.2.1 Bacnet Point Description

2.2.1.1 Bacnet Device

The Gateway virtualizes VRF units as devices according to the specific type of the VRF units, and each device has different properties.

Currently, conventional VRF IDU and ODU are involved.

Each air conditioner connected to the Gateway has a unique BACnet device ID.

Format of a BACnet device ID of a VRF unit: ABCDEFG

	ABC	D	E	FG
Description	BACnet configuration	Port number	System number	VRF unit address
Range	2~400	0~3	0~7	VRF IDU: 0~63 VRF ODU: 96~99

For example, BACnet device ID 192405

Description	BACnet configuration	Port number	System number	VRF unit address
	19	2	4	05

Description: "05" indicates that the device is an IDU (in the range of 0 to 63), the refrigerant system number is 4, the port number is 2, and the BACnet configuration (BACnet address) on the Gateway is 19.

In other words, the device is connected to the Gateway through port 2, and the BACnet configuration (BACnet address) is 19, refrigerant system is 4, and IDU address is 05.

Note: Do not operate an air conditioner too frequently. Otherwise, the internal command queue may fill up, and commands may not be executed in time and become lost. The recommended interval of commands is greater than 500 ms.

2.2.1.2 BACnet Device of VRF IDUs

(1) Device Information Object

Notes:

- ① Object-identifier: BACnet device ID of a VRF IDU
- ② Object-name: Unchangeable IDU name in the format of IDU-port number-system number-IDU address

(2) Object List

Parameter type	Instance	Parameter name	Definition
BI	1	OnOff Status	On/Off status
BI	2	Alarm indication	Fault status
BI	3	AutoMode	Auto mode or not

Parameter type	Instance	Parameter name	Definition
AI	1	Mode	Operating mode
BI	4	AutoFan	Auto fan speed or not
AI	2	FanGear	Fan speed level
AI	3	Setpoint	Set temperature
AI	4	CoolSetpoint	Cooling temperature in auto mode
AI	5	HeatSetpoint	Heating temperature in auto mode
AI	6	Room Temperature	Indoor ambient temperature
AI	7	Malfunction Code	IDU error code
AI	8	LRSwing	Left/Right swing status
AI	9	UDSwing	Up/Down swing status
AI	10	LimitMaxHeatStp	Upper limit of the heating temperature
AI	11	LimitMinHeatStp	Lower limit of the heating temperature
AI	12	LimitMaxCoolStp	Upper limit of the cooling temperature
AI	13	LimitMinCoolStp	Lower limit of the cooling temperature
AI	14	LimitMode	Mode lock status
AI	15	LimitOnOff	On/Off lock status
AI	16	LimitFan	Fan speed lock status
AI	17	LimitUDSwing	Up/Down swing lock status
BI	5	LockRC	Remote controller lock status
BI	6	LockWDC	Wired controller lock status
AI	18	EXV	Opening of the electronic expansion valve
AI	19	T2A	T2A
AI	20	T2B	T2B
AI	21	IDU_Model	Model
AI	22	HP	HP
AI	23	FanGearType	Fan speed type
AO	1	Mode Setting	Operating mode setting
AO	2	Setpoint Setting	Setting of the temperature
AO	3	Cool Setpoint Setting	Setting of the cooling temperature in auto mode
AO	4	Heat Setpoint Setting	Setting of the heating temperature in auto mode
AO	5	Fan Setting	Setting of the operating fan speed
AO	6	LRSwing Setting	Setting of the left/right swing angle
AO	7	UDSwing Setting	Setting of the up/down swing angle
AO	8	SetLimitMaxHeatStp	Setting of the upper limit of the heating temperature
AO	9	SetLimitMinHeatStp	Setting of the lower limit of the heating temperature

Parameter type	Instance	Parameter name	Definition
AO	10	SetLimitMaxCoolStp	Setting of the upper limit of the cooling temperature
AO	11	SetLimitMinCoolStp	Setting of the lower limit of the cooling temperature
AO	12	SetLimitMode	Setting of the mode lock
AO	13	SetLimitOnOff	Setting of the on/off lock
AO	14	SetLimitFan	Setting of the fan speed lock
AO	15	SetLimitUDSwing	Setting of the up/down swing lock
BO	1	SetLockRC	Setting of the remote controller lock
BO	2	SetLockWDC	Setting of the wired controller lock

Note: Certain models do not support all the above parameters. In this case, corresponding parameters do not have a meaning. For example, if an IDU does not support left/right swing, the **LRSwing** parameter of the IDU is meaningless.

Note: Certain models do not support all the above parameter values. If unsupported values are set, the IDU status will be unpredictable. For example, if an IDU does not support Cool mode, and **Mode Setting** is set to **Cool**, the actual operating status of the IDU will be unpredictable. (Depending on the IDU type, the IDU may be off, functioning in cooling mode, or the current operating status may not be changed.)

1 Input Object

(1) On/Off Status

- ① Object-identifier: BI 1
- ② Object-name: On/Off Status
- ③ Present-Value: current value of the variable, read-only, indicating the current on/off status of the IDU

Description	Value
Off	0
On	1

- ④ Inactive-text: Off
- ⑤ Active-text: On

(2) Error Status

- ① Object-identifier: BI 2
- ② Object-name: Alarm indication
- ③ Present-Value: current value of the variable, read-only, indicating whether the IDU has an error

Description	Value
No error	0
Error	1

- ④ Inactive-text: No Error
- ⑤ Active-text: Error

(3) Mode - Auto

- ① Object-identifier: BI 3
- ② Object-name: AutoMode
- ③ Present-Value: current value of the variable, read-only, indicating auto mode or not

Description	Value
Not auto mode	0
Auto mode	1

- ④ Inactive-text: Not AutoMode
- ⑤ Active-text: AutoMode

Note: Combine both **Mode** (AI 1) and **AutoMode** (BI 3) to determine the current operating mode of the IDU. When **AutoMode** (BI 3) is 0, **Mode** (AI 1) indicates the current operating mode of the IDU. When **AutoMode** (BI 3) is 1, the IDU is in auto mode, and **Mode** (AI 1) indicates the actual operating status of the IDU in auto mode.

(4) Mode - Operating Mode

- ① Object-identifier: AI 1
- ② Object-name: Mode
- ③ Present-Value: current value of the variable, read-only, indicating the current operating mode of the IDU

VRF unit	Value
Off	0
Fan	1
Cool	2
Heat	3
Dry	6

Note: Combine both **Mode** (AI 1) and **AutoMode** (BI 3) to determine the current operating mode of the IDU. When **AutoMode** (BI 3) is 0, **Mode** (AI 1) indicates the current operating mode of the IDU. When **AutoMode** (BI 3) is 1, the IDU is in auto mode, and **Mode** (AI 1) indicates the actual operating status of the IDU in auto mode.

(5) Fan Speed - Auto

- ① Object-identifier: BI 4
- ② Object-name: AutoFan
- ③ Present-Value: current value of the variable, read-only, indicating auto fan speed or not

Description	Value
Not auto fan speed	0
Auto fan speed	1

- ④ Inactive-text: Not AutoFan
- ⑤ Active-text: AutoFan

Note: Combine both **AutoFan** (BI 4) and **FanGear** (AI 2) to determine the current fan speed of the IDU. When **AutoFan** (BI 4) is 0, **FanGear** (AI 2) indicates the current fan speed of the IDU. When **AutoFan** (BI 4) is 1, the IDU is operating at auto fan speed, and **FanGear** (AI 2) indicates the actual fan speed level.

(6) Fan Speed - Level

- ① Object-identifier: AI 2
- ② Object-name: FanGear
- ③ Present-Value: current value of the variable, read-only, indicating the current fan speed of the IDU

Description	Value
Fan speed 1 (low speed)	1
Fan speed 2 (low speed)	2
Fan speed 3 (medium speed)	3
Fan speed 4 (medium speed)	4
Fan speed 5 (high speed)	5
Fan speed 6 (high speed)	6
Fan speed 7 (high speed)	7

Note: Combine both **AutoFan** (BI 4) and **FanGear** (AI 2) to determine the current fan speed of the IDU. When **AutoFan** (BI 4) is 0, **FanGear** (AI 2) indicates the current fan speed of the IDU. When **AutoFan** (BI 4) is 1, the IDU is operating at auto fan speed, and **FanGear** (AI 2) indicates the actual fan speed level.

(7) Set Temperature

- ① Object-identifier: AI 3
- ② Object-name: Setpoint
- ③ Present-Value: current value of the variable, read-only, indicating the current set temperature of the IDU

Note: In auto mode, two values are set for the IDU: CoolSetpoint (AI 4) and HeatSetpoint (AI 5). In other modes, Setpoint (AI 3) is set.

(8) Cooling Temperature in Auto Mode

- ① Object-identifier: AI 4
- ② Object-name: Cool Setpoint
- ③ Present-Value: current value of the variable, read-only, indicating the set cooling temperature of the IDU in auto mode

Note: In auto mode, two values are set for the IDU: CoolSetpoint (AI 4) and HeatSetpoint (AI 5). In other modes, Setpoint (AI 3) is set.

(9) Heating Temperature in Auto Mode

- ① Object-identifier: AI 5
- ② Object-name: Heat Setpoint
- ③ Present-Value: current value of the variable, read-only, indicating the set heating temperature of the IDU in auto mode

Note: In auto mode, two values are set for the IDU: CoolSetpoint (AI 4) and HeatSetpoint (AI 5). In other modes, Setpoint (AI 3) is set.

(10) Indoor Ambient Temperature

- ① Object-identifier: AI 6
- ② Object-name: Room Temperature
- ③ Present-Value: current value of the variable, read-only, indicating the current indoor ambient temperature of the IDU

(11) Error Code

- ① Object-identifier: AI 7
- ② Object-name: Malfunction Code
- ③ Present-Value: current value of the variable, read-only, indicating the current error code of the IDU

Bit	Meaning	Value
Low byte of the error code + Bit 0 of the high byte of the error code	Error code table	0: No error 01-20: A0-AF, AH, AL, AP, AU 21-40: b0-bF, bH, bL, bP, bU 41-60: C0-CF, CH, CL, CP, CU 61-80: E0-EF, EH, EL, EP, EU 81-100: F0-FF, FH, FL, FP, FU 101-120: H0-HF, HH, HL, HP, HU 121-140: L0-LF, LH, LL, LP, LU 141-160: J0-JF, JH, JL, JP, JU 161-180: n0-nF, nH, nL, nP, nU 181-200: P0-PF, PH, PL, PP, PU 201-220: r0-rF, rH, rL, rP, rU 221-240: t0-tF, tH, tL, tP, tU 241-260: U0-UF, UH, UL, UP, UU Others: reserved
Bits 1–4 of the high byte of the error code	Error segmentation	0: indicates no segmentation 1–15: indicates error segmentations 1–15, respectively, and adds details after the main error
Bits 5–7 of the high byte of the error code	System error or the ID of the faulty component	0: indicates a system error 1–7: indicates the ID of the faulty compressor, fan, or EXV

For example, error code 693 is 0000001010110101 in binary, and can be divided to three sections as 000---0001---010110101.

Bit	Binary section	Description
Bits 5–7 of the high byte of the error code	000	Indicates a system error or error segmentation 2. Value 0 indicates a system error.
Bits 1–4 of the high byte of the error code	0001	Error segmentation 1
Low byte of the error code + Bit 0 of the high byte of the error code	010110101	Value 181 corresponds to P0.

Note: The example here is for demonstration purposes only, and does not exist.

Note: For error segmentations and system error or ID of the faulty component, refer to the corresponding manual of the IDU.

(12) Swing Left/Right

- ① Object-identifier: AI 8
- ② Object-name: LRSwing
- ③ Present-Value: current value of the variable, read-only, indicating the current left/right swing status of the IDU

Description	Value
No swing left/right	0
Angle 1	1
Angle 2	2
Angle 3	3
Angle 4	4
Angle 5	5
Auto swing	14

(13) Swing Up/Down

- ① Object-identifier: AI 9
- ② Object-name: UDSSwing
- ③ Present-Value: current value of the variable, read-only, indicating the current up/down swing status of the IDU

Description	Value
No swing up/down	0
Angle 1	1
Angle 2	2
Angle 3	3
Angle 4	4
Angle 5	5
Auto swing	14

(14) Upper Limit of the Heating Temperature

- ① Object-identifier: AI 10
- ② Object-name: LimitMaxHeatStp
- ③ Present-Value: current value of the variable, read-only, indicating the current upper limit of the heating temperature of the IDU

Description	Value
Upper Limit of the Heating Temperature	The parameter range depends on the IDU.

(15) Lower Limit of Heating Temperature

- ① Object-identifier: AI 11
- ② Object-name: LimitMinHeatStp
- ③ Present-Value: current value of the variable, read-only, indicating the current lower limit of the heating temperature of the IDU

Description	Value
Lower Limit of Heating Temperature	The parameter range depends on the IDU.

(16) Upper Limit of Cooling Temperature

- ① Object-identifier: AI 12
- ② Object-name: LimitMaxCoolStp
- ③ Present-Value: current value of the variable, read-only, indicating the current upper limit of the cooling temperature of the IDU

Description	Value
Upper Limit of Cooling Temperature	The parameter range depends on the IDU.

(17) Lower Limit of the Cooling Temperature

- ① Object-identifier: AI 13
- ② Object-name: LimitMinCoolStp
- ③ Present-Value: current value of the variable, read-only, indicating the current lower limit of the cooling temperature of the IDU

Description	Value
Lower Limit of the Cooling Temperature	The parameter range depends on the IDU.

(18) Mode Lock

- ① Object-identifier: AI 14
- ② Object-name: LimitMode
- ③ Present-Value: current value of the variable, read-only, indicating the currently locked mode of the IDU

VRF unit	Value
Unlocked	0/255
Fan mode locked	1
Cool mode locked	2
Heat mode locked	3
Dry mode locked	6
Auto mode locked	241

(19) On/Off Lock

- ① Object-identifier: AI 15
- ② Object-name: LimitOnOff
- ③ Present-Value: current value of the variable, read-only, indicating the current on/off lock status of the IDU

Description	Value
Unlocked	0
On locked	1
Off locked	2

(20) Fan Speed Lock

- ① Object-identifier: AI 16
- ② Object-name: LimitFan
- ③ Present-Value: current value of the variable, read-only, indicating the currently locked fan speed of the IDU

Description	Value
Unlocked	0
Fan speed 1 (low speed)	1
Fan speed 2 (low speed)	2
Fan speed 3 (medium speed)	3
Fan speed 4 (medium speed)	4
Fan speed 5 (high speed)	5
Fan speed 6 (high speed)	6
Fan speed 7 (high speed)	7

(21) Swing Up/Down Lock

- ① Object-identifier: AI 17
- ② Object-name: LimitUDSwing
- ③ Present-Value: current value of the variable, read-only, indicating the current up/down swing lock status of the IDU

Description	Value
Unlocked	0
Angle 1 locked	1
Angle 2 locked	2
Angle 3 locked	3
Angle 4 locked	4
Angle 5 locked	5
Auto swing locked	14

(22) Remote Controller Lock

- ① Object-identifier: BI 5
- ② Object-name: LockRC
- ③ Present-Value: current value of the variable, read-only, indicating the current remote controller lock status of the IDU

Description	Value
Unlocked	0
Locked	1

- ④ Inactive-text: Unlock
- ⑤ Active-text: Lock

(23) Wired Controller Lock

- ① Object-identifier: BI 6
- ② Object-name: LockWDC
- ③ Present-Value: current value of the variable, read-only, indicating the current wired controller lock status of the IDU

Description	Value
Unlocked	0
Locked	1

- ④ Inactive-text: Unlock
- ⑤ Active-text: Lock

(24) EXV Opening

- ① Object-identifier: AI 18
- ② Object-name: EXV
- ③ Present-Value: current value of the variable, read-only, indicating the current EXV opening of the IDU

(25) T2A

- ① Object-identifier: AI 19
- ② Object-name: T2A
- ③ Present-Value: current value of the variable, read-only, indicating the current T2A of the IDU

(26) T2B

- ① Object-identifier: AI 20
- ② Object-name: T2B
- ③ Present-Value: current value of the variable, read-only, indicating the current T2B of the IDU

(27) IDU Model

- ① Object-identifier: AI 21
- ② Object-name: IDU_Model
- ③ Present-Value: current value of the variable, read-only, indicating the IDU model

Description	Value
Old IDU	0
4-Way Cassette (4-WAY)	1
Wall-mounted	2
Medium Static Pressure Duct (M-Duct)	3
Low Static Pressure Duct (L-Duct)	4
Air Handling Unit (AHU)	5
High Static Pressure Duct (H-Duct)	6
Compact 4-Way Cassette(COMPACT)	7
Ceiling & Floor	8
Floor Standing	9
Floor Standing	10
Fresh Air Processing Unit	11
Inverter Split AC	12
HRV	13
1-Way Cassette	14
2-Way Cassette	15
console	16
HTHM	17
Fresh Air Processing Unit	18
Fresh Air Processing Unit	20

Description	Value
AHUKIT (return air control)	21
Floor Standing	22
AHUKIT (discharge air control)	24

Note: Because new models are released regularly, some values may not be listed in the table. For the meaning of specific values, please contact the technical support.

(28) IDU HP

- ① Object-identifier: AI 22
- ② Object-name: HP
- ③ Present-Value: current value of the variable, read-only, indicating the IDU HP

(29) IDU Fan Speed Type

- ① Object-identifier: AI 23
- ② Object-name: FanGearType
- ③ Present-Value: current value of the variable, read-only, indicating the IDU fan speed type

Description	Value
Fan speed 3	0
Fan speed 7	1

2 Output Object

(1) Mode Setting

- ① Object-identifier: AO 1
- ② Object-name: Mode Setting
- ③ Present-Value: current value of the variable, write-only, setting the operating mode of the IDU. On indicates turning the IDU on and operating in the last mode.

Description	Value
On	239
Off	240
Auto	241
Fan	1
Cool	2
Heat	3
Fresh	5
Dry	6

(2) Set Temperature

- ① Object-identifier: AO 2
- ② Object-name: Setpoint Setting
- ③ Present-Value: current value of the variable, write-only, indicating the set temperature of the IDU

Note: In auto mode, two values are set for the IDU: Cool Setpoint Setting (AO 3) and Heat Setpoint Setting (AO 4). In other modes, Setpoint Setting (AO 2) is set.

(3) Cooling Temperature in Auto Mode

- ① Object-identifier: AO 3
- ② Object-name: Cool Setpoint Setting
- ③ Present-Value: current value of the variable, write-only, setting the cooling temperature of the IDU in auto mode

Note: In auto mode, two values are set for the IDU: Cool Setpoint Setting (AO 3) and Heat Setpoint Setting (AO 4). In other modes, Setpoint Setting (AO 2) is set.

(4) Heating Temperature in Auto Mode

- ① Object-identifier: AO 4
- ② Object-name: Heat Setpoint Setting
- ③ Present-Value: current value of the variable, write-only, setting the heating temperature of the IDU in auto mode

Note: In auto mode, two values are set for the IDU: Cool Setpoint Setting (AO 3) and Heat Setpoint Setting (AO 4). In other modes, Setpoint Setting (AO 2) is set.

(5) Fan Speed Setting

- ① Object-identifier: AO 5
- ② Object-name: Fan Setting
- ③ Present-Value: current value of the variable, write-only, setting the operating fan speed of the IDU

Description	Value
Fan speed 1	1
Fan speed 2	2
Fan speed 3	3
Fan speed 4	4
Fan speed 5	5
Fan speed 6	6
Fan speed 7	7
Automatic	241

(6) Setting Swing Left/Right

- ① Object-identifier: AO 6
- ② Object-name: LRSwing Setting
- ③ Present-Value: current value of the variable, write-only, setting the left/right swing of the IDU

Description	Value
Angle 1	1
Angle 2	2
Angle 3	3
Angle 4	4
Angle 5	5
Automatic	14

(7) Setting Swing Up/Down

- ① Object-identifier: AO 7
- ② Object-name: UDSwing Setting
- ③ Present-Value: current value of the variable, write-only, setting the up/down swing of the IDU

Description	Value
Angle 1	1
Angle 2	2
Angle 3	3
Angle 4	4
Angle 5	5
Automatic	14

(8) Setting of the Upper Limit of the Heating Temperature

- ① Object-identifier: AO 8
- ② Object-name: SetLimitMaxHeatStp
- ③ Present-Value: current value of the variable, write-only, setting the upper limit of the heating temperature of the IDU

(9) Setting of the Lower Limit of the Heating Temperature

- ① Object-identifier: AO 9
- ② Object-name: SetLimitMinHeatStp
- ③ Present-Value: current value of the variable, write-only, setting the lower limit of the heating temperature of the IDU

(10) Setting of the Upper Limit of Cooling Temperature

- ① Object-identifier: AO 10
- ② Object-name: SetLimitMaxCoolStp
- ③ Present-Value: current value of the variable, write-only, setting the upper limit of the cooling temperature of the IDU

(11) Setting of the Lower Limit of the Cooling Temperature

- ① Object-identifier: AO 11
- ② Object-name: SetLimitMinCoolStp
- ③ Present-Value: current value of the variable, write-only, setting the lower limit of the cooling temperature of the IDU

(12) Mode Lock

- ① Object-identifier: AO 12
- ② Object-name: SetLimitMode
- ③ Present-Value: current value of the variable, write-only, locking the operating mode of the IDU

VRF unit status	Value
Unlock	0
Fan mode locked	1
Cool mode locked	2
Heat mode locked	3
Dry mode locked	6
Auto mode locked	241

(13) On/Off Lock

- ① Object-identifier: AO 13
- ② Object-name: SetLimitOnOff
- ③ Present-Value: current value of the variable, write-only, locking on/off status of the IDU

Description	Value
Unlocked	0
On locked	1
Off locked	2

(14) Fan Speed Lock

- ① Object-identifier: AO 14
- ② Object-name: SetLimitFan
- ③ Present-Value: current value of the variable, write-only, locking fan speed of the IDU

Description	Value
Unlocked	0
Fan speed 1 (low speed) locked	1
Fan speed 2 (low speed) locked	2
Fan speed 3 (medium speed) locked	3
Fan speed 4 (medium speed) locked	4
Fan speed 5 (high speed) locked	5
Fan speed 6 (high speed) locked	6
Fan speed 7 (high speed) locked	7

(15) Swing Up/Down Lock

- ① Object-identifier: AO 15
- ② Object-name: SetLimtUDSwing
- ③ Present-Value: current value of the variable, write-only, locking up/down swing of the IDU

Description	Value
Unlocked	0
Angle 1 locked	1
Angle 2 locked	2
Angle 3 locked	3
Angle 4 locked	4
Angle 5 locked	5
Auto swing locked	14

(16) Remote Controller Lock

- ① Object-identifier: BO 1
- ② Object-name: SetLockRC
- ③ Present-Value: current value of the variable, write-only, locking the remote controller of the IDU

Description	Value
Unlock	0
Lock	1

(17) Wired Controller Lock

- ① Object-identifier: BO 2
- ② Object-name: SetLockWDC
- ③ Present-Value: current value of the variable, write-only, locking the wired controller of the IDU

Description	Value
Unlock	0
Lock	1

2.2.1.3 BACnet Device of VRF ODUs

(1) Device Information Object

Notes:

- ① Object-identifier: BACnet device ID of a VRF ODU
- ② Object-name: Unchangeable ODU name in the format of ODU-port number-system number-ODU address

(2) Object List

Parameter type	Instance	Parameter name	Definition
BI	1	OnOff Status	On/Off status
BI	2	Alarm indication	Is there an error
AI	1	Mode	Operating Mode
AI	2	Fan 1 Speed	Fan 1 speed
AI	3	Fan 2 Speed	Fan 2 speed
BI	3	Fan 1 Status	Fan 1 on/off status
BI	4	Fan 2 Status	Fan 2 on/off status
AI	4	Ambient Temperature	Outdoor ambient temperature
AI	5	Compressor 1 Freq	Compressor 1 frequency
AI	6	Compressor 2 Freq	Compressor 2 frequency
BI	5	Compressor 1 Status	Compressor 1 on/off status
BI	6	Compressor 2 Status	Compressor 2 on/off status
AI	7	Compressor 1 Discharge Temperature	Discharge temperature of compressor 1
AI	8	Compressor 2 Discharge Temperature	Discharge temperature of compressor 2
AI	9	High Pressure	High pressure
AI	10	Low Pressure	Low pressure
AI	11	Malfunction code	Error code

Parameter type	Instance	Parameter name	Definition
AI	12	T3	T3
AI	13	Exhaust Temperature	Discharge superheat
AI	14	Compressor 1 Current	Compressor 1 current
AI	15	Compressor 2 Current	Compressor 2 current
AI	16	HP	HP
AI	17	EXV1	EXV1
AI	18	EXV2	EXV2
AI	19	EXV3	EXV3
AI	20	EXV4	EXV4
BI	7	SV1	SV1
BI	8	SV2	SV2
BI	9	SV3	SV3
BI	10	SV4	SV4
BI	11	SV5	SV5
BI	12	SV6	SV6
BI	13	SV7	SV7
BI	14	SV8	SV8
BI	15	SV8b	SV8b
BI	16	SV9	SV9
BI	17	ST1	ST1
BI	18	ST2	ST2
BI	19	ST3	ST3
BI	20	Crank 1	Auxiliary electric heater 1
BI	21	Crank 2	Auxiliary electric heater 2
BO	1	Emergency Stop	Emergency stop control

1 Input Object(AI/BI)

(1) On/Off Status

- ① Object-identifier: BI 1
- ② Object-name: On/Off Status
- ③ Present-Value: current value of the variable, read-only, indicating the current on/off status of the ODU

Description	Value
Off	0
On	1

④ Inactive-text: Off

⑤ Active-text: On

(2) Error Status

① Object-identifier: BI 2

② Object-name: alarm indication

③ Present-Value: current value of the variable, read-only, indicating whether the IDU has an error

Description	Value
No error	0
Error	1

④ Inactive-text: No Error

⑤ Active-text: Error

(3) Operating Mode

① Object-identifier: AI 1

② Object-name: Mode

③ Present-Value: current value of the variable, read-only, indicating the current operating mode of the ODU

Description	Value
Off	0
Cool	2
Heat	3
Forced cooling	4
Mix-cooling	29
Mix-heating	30

(4) Fan 1 Speed

① Object-identifier: AI 2

② Object-name: Fan1

③ Present-Value: current value of the variable, read-only, indicating fan 1 speed of the ODU

(5) Fan 2 Speed

① Object-identifier: AI 3

② Object-name: Fan2

③ Present-Value: current value of the variable, read-only, indicating fan 2 speed of the ODU

(6) Fan 1 Status

- ① Object-identifier: BI 3
- ② Object-name: Fan1 Status
- ③ Present-Value: current value of the variable, read-only, indicating fan 1 status of the ODU

Description	Value
Off	0
On	1

- ④ Inactive-text: Off
- ⑤ Active-text: On

(7) Fan 2 Status

- ① Object-identifier: BI 4
- ② Object-name: Fan2 Status
- ③ Present-Value: current value of the variable, read-only, indicating fan 2 status of the ODU

Description	Value
Off	0
On	1

- ④ Inactive-text: Off
- ⑤ Active-text: On

(8) Outdoor Ambient Temperature

- ① Object-identifier: AI 4
- ② Object-name: Ambient Temperature
- ③ Present-Value: current value of the variable, read-only, indicating the current outdoor ambient temperature

(9) Compressor 1 Frequency

- ① Object-identifier: AI 5
- ② Object-name: Compressor 1 Freq
- ③ Present-Value: current value of the variable, read-only, indicating compressor 1 frequency of the ODU

(10) Compressor 2 Frequency

- ① Object-identifier: AI 6
- ② Object-name: Compressor 2 Freq
- ③ Present-Value: current value of the variable, read-only, indicating compressor 2 frequency of the ODU

(11) Compressor 1 Status

- ① Object-identifier: BI 5
- ② Object-name: Compressor 1 Status
- ③ Present-Value: current value of the variable, read-only, indicating compressor 1 status of the ODU

Description	Value
Off	0
On	1

- ④ Inactive-text: Off
- ⑤ Active-text: On

(12) Compressor 2 Status

- ① Object-identifier: BI 6
- ② Object-name: Compressor 2 Status
- ③ Present-Value: current value of the variable, read-only, indicating compressor 2 status of the ODU

Description	Value
Off	0
On	1

- ④ Inactive-text: Off
- ⑤ Active-text: On

(13) Discharge Temperature of Compressor 1

- ① Object-identifier: AI 7
- ② Object-name: Compressor 1 Discharge Temperature
- ③ Present-Value: current value of the variable, read-only, indicating compressor 1 discharge temperature of the ODU

(14) Discharge Temperature of Compressor 2

- ① Object-identifier: AI 8
- ② Object-name: Compressor 2 Discharge Temperature
- ③ Present-Value: current value of the variable, read-only, indicating compressor 2 discharge temperature of the ODU

(15) High Pressure

- ① Object-identifier: AI 9
- ② Object-name: High Pressure
- ③ Present-Value: current value of the variable, read-only, indicating high pressure of the ODU

(16) Low Pressure

- ① Object-identifier: AI 10
- ② Object-name: Low Pressure
- ③ Present-Value: current value of the variable, read-only, indicating low pressure of the ODU

(17) Error Code

- ① Object-identifier: AI 11
- ② Object-name: Malfunction code
- ③ Present-Value: current value of the variable, read-only, indicating an error code of the ODU

Bit	Meaning	Value
Low byte of the error code + Bit 0 of the high byte of the error code	Error code table	0: No error 01-20: A0-AF, AH, AL, AP, AU 21-40: b0-bF, bH, bL, bP, bU 41-60: C0-CF, CH, CL, CP, CU 61-80: E0-EF, EH, EL, EP, EU 81-100: F0-FF, FH, FL, FP, FU 101-120: H0-HF, HH, HL, HP, HU 121-140: L0-LF, LH, LL, LP, LU 141-160: J0-JF, JH, JL, JP, JU 161-180: n0-nF, nH, nL, nP, nU 181-200: P0-PF, PH, PL, PP, PU 201-220: r0-rF, rH, rL, rP, rU 221-240: t0-tF, tH, tL, tP, tU 241-260: U0-UF, UH, UL, UP, UU Others: reserved
Bits 1-4 of the high byte of the error code	Error segmentation	0: indicates no segmentation 1-15: indicates error segmentations 1-15, respectively, and adds details after the main error
Bits 5-7 of the high byte of the error code	System error or the ID of the faulty component	0: indicates a system error 1-7: indicates the ID of the faulty compressor, fan, or EXV

For example, error code 693 is 0000001010110101 in binary, and can be divided to three sections as 000---0001---010110101.

Bit	Binary section	Description
Bits 5–7 of the high byte of the error code	000	Low byte of the error code + Bit 0 of the high byte of the error code
Bits 1–4 of the high byte of the error code	0001	Error segmentation 1
Low byte of the error code + Bit 0 of the high byte of the error code	010110101	Low byte of the error code + Bit 0 of the high byte of the error code

Note: The example here is for demonstration purposes only, and does not exist.

Note: For error segmentations and system error or ID of the faulty component, refer to the corresponding manual of the ODU.

(18) T3

- ① Object-identifier: AI 12
- ② Object-name: T3
- ③ Present-Value: current value of the variable, read-only, indicating the T3 sensor temperature of the ODU

(19) Discharge Superheat

- ① Object-identifier: AI 13
- ② Object-name: Exhaust Temperature
- ③ Present-Value: current value of the variable, read-only, indicating discharge superheat of the ODU

(20) Compressor 1 Current

- ① Object-identifier: AI 14
- ② Object-name: Compressor 1 Current
- ③ Present-Value: current value of the variable, read-only, indicating compressor 1 current of the ODU

(21) Compressor 2 Current

- ① Object-identifier: AI 15
- ② Object-name: Compressor 2 Current
- ③ Present-Value: current value of the variable, read-only, indicating compressor 2 current of the ODU

(22) ODU HP

- ① Object-identifier: AI 16
- ② Object-name: HP
- ③ Present-Value: current value of the variable, read-only, indicating the ODU HP

(22) EXV1

- ① Object-identifier: AI 17
- ② Object-name: EXV1
- ③ Present-Value: current value of the variable, read-only, indicating EXV 1 opening of the ODU

(23) EXV2

- ① Object-identifier: AI 18
- ② Object-name: EXV2
- ③ Present-Value: current value of the variable, read-only, indicating EXV 2 opening of the ODU

(24) EXV3

- ① Object-identifier: AI 19
- ② Object-name: EXV3
- ③ Present-Value: current value of the variable, read-only, indicating EXV 3 opening of the ODU

(25) EXV4

- ① Object-identifier: AI 20
- ② Object-name: EXV4
- ③ Present-Value: current value of the variable, read-only, indicating EXV 4 opening of the ODU

(26) SV1

- ① Object-identifier: BI 7
- ② Object-name: SV1
- ③ Present-Value: current value of the variable, read-only, indicating SV 1 status of the ODU

Description	Value
Off	0
On	1

- ④ Inactive-text: Off
- ⑤ Active-text: On

(27) SV2

- ① Object-identifier: BI 8
- ② Object-name: SV2
- ③ Present-Value: current value of the variable, read-only, indicating SV 2 status of the ODU

Description	Value
Off	0
On	1

- ④ Inactive-text: Off
- ⑤ Active-text: On

(28) SV3

- ① Object-identifier: BI 9
- ② Object-name: SV3
- ③ Present-Value: current value of the variable, read-only, indicating SV 3 status of the ODU

Description	Value
Off	0
On	1

- ④ Inactive-text: Off
- ⑤ Active-text: On

(29) SV4

- ① Object-identifier: BI 10
- ② Object-name: SV4
- ③ Present-Value: current value of the variable, read-only, indicating SV 4 status of the ODU

Description	Value
Off	0
On	1

- ④ Inactive-text: Off
- ⑤ Active-text: On

(30) SV5

- ① Object-identifier: BI 11
- ② Object-name: SV5
- ③ Present-Value: current value of the variable, read-only, indicating SV 5 status of the ODU

Description	Value
Off	0
On	1

④ Inactive-text: Off

⑤ Active-text: On

(31) SV6

① Object-identifier: BI 12

② Object-name: SV6

③ Present-Value: current value of the variable, read-only, indicating SV 6 status of the ODU

Description	Value
Off	0
On	1

④ Inactive-text: Off

⑤ Active-text: On

(32) SV7

① Object-identifier: BI 13

② Object-name: SV7

③ Present-Value: current value of the variable, read-only, indicating SV 7 status of the ODU

Description	Value
Off	0
On	1

④ Inactive-text: Off

⑤ Active-text: On

(33) SV8

① Object-identifier: BI 14

② Object-name: SV8

③ Present-Value: current value of the variable, read-only, indicating SV 8 status of the ODU

Description	Value
Off	0
On	1

④ Inactive-text: Off

⑤ Active-text: On

(34) SV8b

- ① Object-identifier: BI 15
- ② Object-name: SV8b
- ③ Present-Value: current value of the variable, read-only, indicating SV8b status of the ODU

Description	Value
Off	0
On	1

- ④ Inactive-text: Off
- ⑤ Active-text: On

(35) SV9

- ① Object-identifier: BI 16
- ② Object-name: SV9
- ③ Present-Value: current value of the variable, read-only, indicating SV 9 status of the ODU

Description	Value
Off	0
On	1

- ④ Inactive-text: Off
- ⑤ Active-text: On

(36) ST1

- ① Object-identifier: BI 17
- ② Object-name: ST1
- ③ Present-Value: current value of the variable, read-only, indicating ST 1 status of the ODU

Description	Value
Off	0
On	1

- ④ Inactive-text: Off
- ⑤ Active-text: On

(37) ST2

- ① Object-identifier: BI 18
- ② Object-name: ST2
- ③ Present-Value: current value of the variable, read-only, indicating ST 2 status of the ODU

Description	Value
Off	0
On	1

④ Inactive-text: Off

⑤ Active-text: On

(38) ST3

① Object-identifier: BI 19

② Object-name: ST3

③ Present-Value: current value of the variable, read-only, indicating ST 3 status of the ODU

Description	Value
Off	0
On	1

④ Inactive-text: Off

⑤ Active-text: On

(39) Electric Heater 1

① Object-identifier: BI 20

② Object-name: Crank1

③ Present-Value: current value of the variable, read-only, indicating electric heater 1 status of the ODU

Description	Value
Off	0
On	1

④ Inactive-text: Off

⑤ Active-text: On

(40) Electric Heater 2

① Object-identifier: BI 21

② Object-name: Crank2

③ Present-Value: current value of the variable, read-only, indicating electric heater 2 status of the ODU

Description	Value
Off	0
On	1

- ④ Inactive-text: Off
- ⑤ Active-text: On

2 Output Object(AO/BO)

(1) Emergency Stop

- ① Object-identifier: BO 1
- ② Object-name: Emergency Stop
- ③ Present-Value: current value of the variable, write-only, indicating the ODU emergency stop command

Description	Value
Off	0
On	1

- ④ Inactive-text: Inactive Emergency Stop
- ⑤ Active-text: Active Emergency Stop

This parameter will trigger the emergency stop logic of the ODU. For more information, refer to the relevant description of the ODU. If the ODU's emergency stop is triggered by using this parameter, the status needs to be released by this parameter. Otherwise, the ODU remains in the emergency stop status.

2.2.1.4 COV Function Description

The Gateway provides COV services of Confirm and UnConfirm types.

If the BMS system of the upper computer subscribes to the COV service of the Confirm type of a variable, and the variable value changes, the Gateway sends a Notify packet to the upper computer, and the upper computer returns an ACK message to the Gateway.

If the BMS system of the upper computer subscribes to the COV service of the UnConfirm type of a variable, and the variable value changes, the Gateway sends a Notify packet to the upper computer, and the upper computer does not reply.

The COV service that the upper computer subscribes to has a lifetime, which is set on the upper computer.

2.3 Web Functions

The Gateway is embedded with a web server, which can be used to upgrade and configure the Gateway.

The default IP address of the Gateway is 192.168.1.8. In the address bar of the Chrome browser (*4), enter "https://Gateway IP address" to open the web page of the Gateway (*5).

Username: admin

Default password: 123AB@ab

Note: The password is case-sensitive.

*4: Other browsers may be incompatible, preventing the Web function from working properly.

*5:

1. The PC and the Gateway need to be in the same network segment. For specific settings, consult relevant IT personnel.
2. The PC OS can be Windows 7 (32-bit or 64-bit) or later versions.
3. The resolution of the PC cannot be lower than 1600 x 900.
4. Chrome browser needs to be in 70.0 or any later version.

If the PC IP address is, for example, 192.168.1.100 and you enter "https://192.168.1.8" in the address bar of the Chrome browser, the following page will be displayed:

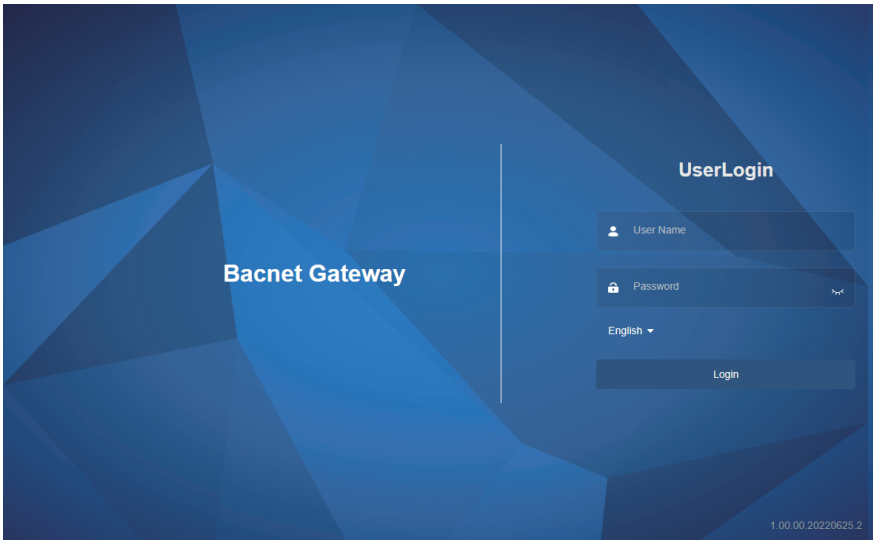

Click **English** to switch the language.

Note: The language selection uses your browser's cache. When the browser is changed or the browser cache is cleared, the default language is restored.

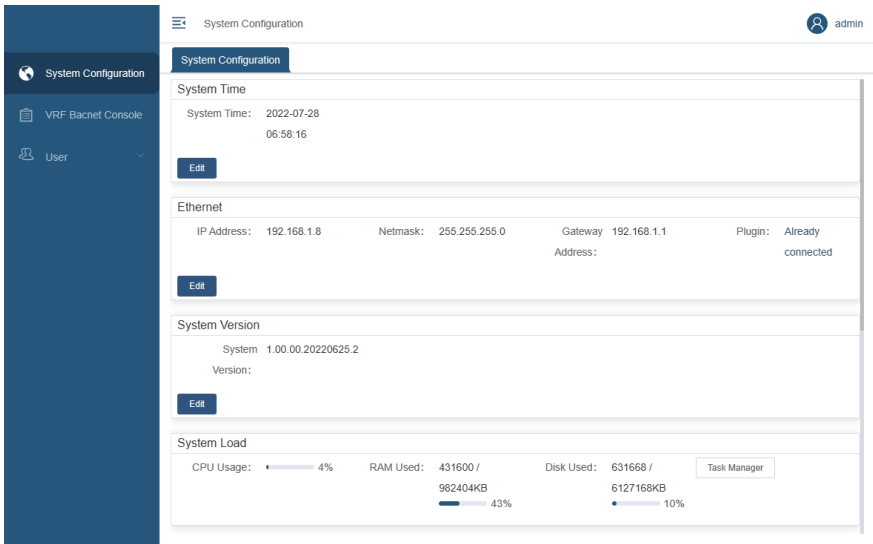

Web function list

Level-1 function module	Level-2 function module	Remarks
System Configuration	System Time	Changes the Gateway time.
	Ethernet	Changes the Gateway IP address.
	System Version	Displays the Gateway version and upgrades the Gateway firmware.
	System Load	Displays the usage of the Gateway CPU and memory.
	Bacnet Configuration	Configures the BACnet address and port, and enables or disables the debug mode of VRF units.
	Impedance matching	Enable or disable impedance matching for buses.
	System Operation	Restarts the Gateway.
VRF Bacnet Console	/	Verifies whether the BACnet function works normally.
User	/	Manages user accounts.

2.3.1 System Configuration

2.3.1.1 System Time

System Time	
System Time:	2022-07-28 06:58:16
<input type="button" value="Edit"/>	

Click "Edit" to open the system time setting dialog box, and click the time area

to open the system time change window. Change the time and click "Submit".

Edit - System Time

* System Time

2.3.1.2 Ethernet

Ethernet			
IP Address:	192.168.1.8	Netmask:	255.255.255.0
Gateway Address:	192.168.1.1	Plugin:	Already connected
<input type="button" value="Edit"/>			

Click "Edit" to open the Ethernet setting dialog box. Enter the correct default gateway address, IP address, and subnet mask, and then click "Submit".

Note: After changing the IP address, you are advised to restart the Gateway. Otherwise, some functions will be unavailable.

Note: After you change the IP address, this page will be unavailable, and you need to log in again using the new IP address.

2

2.3.1.3 System Version

2

Click "Edit" in the pane, click "Select the file", and select the desired firmware. (If a correct file is selected, the selected firmware version will be displayed.) Confirm the version and select upgrade and restart or upgrade without restarting. If the file is incorrect, verification will fail and the system will indicate an error.

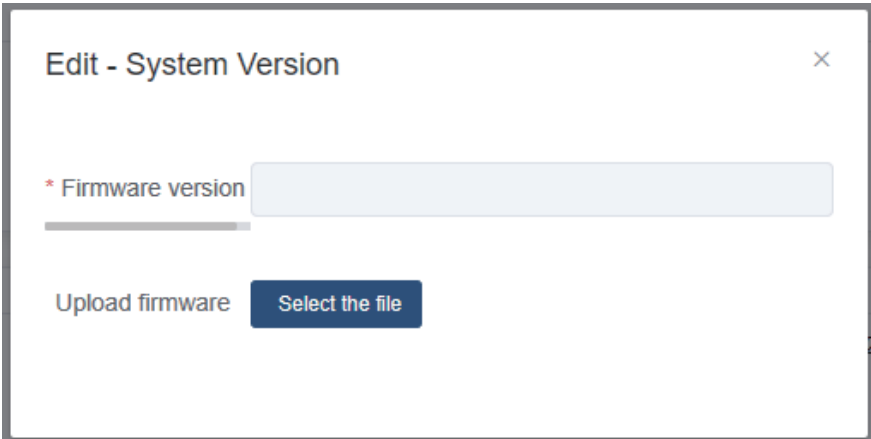

Note: It takes 2-3 minutes to verify an upgrade file. While a file is being verified, do not refresh the page. Wait for the verification to complete.

Upgrading firmware or restarting the gateway will not change the gateway's original settings.

2.3.1.4 System Load

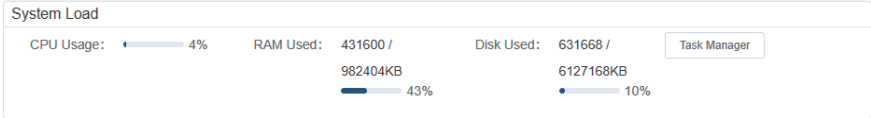

This pane displays the usage of the CPU, memory, and storage of the current device. You can click "Task Manager" to check relevant information about key processes.

2.3.1.5 Bacnet Configuration

Bacnet Configuration			
Bacnet	19	BACNet Port:	47808
		Device ID:	19999
		Device Name:	BACNET GATEWAY
Configuration:			
Debug Mode:	true	DDC ID:	ddc0
Edit			

Bacnet: BACnet address (The default value is 19 and the value range is 2 to 400.)

BACNet Port: The default value is 47808 and the value range is 1 to 65534.

After the change, click "Submit" to save the configuration.

Debug Mode is enabled by default. When Debug Mode is enabled, you can check whether the BACnet function of the Gateway is normal on the **VRF Bacnet Console** page.

After the internal verification, be sure to disable Debug Mode.

Edit - Bacnet Configuration ✕

* Bacnet Configurat

* BACNet Port

* Device ID 19999

* Device Name BACNET GATEWAY

* Debug Mode

* DDC ID ddc0

2.3.1.6 Impedance Matching

Impedance matching		
BUS1:	Impedance	BUS2: Impedance
	matching	matching
	disable	disable
		BUS3: Impedance
		matching
		disable
<input type="button" value="Edit"/>		

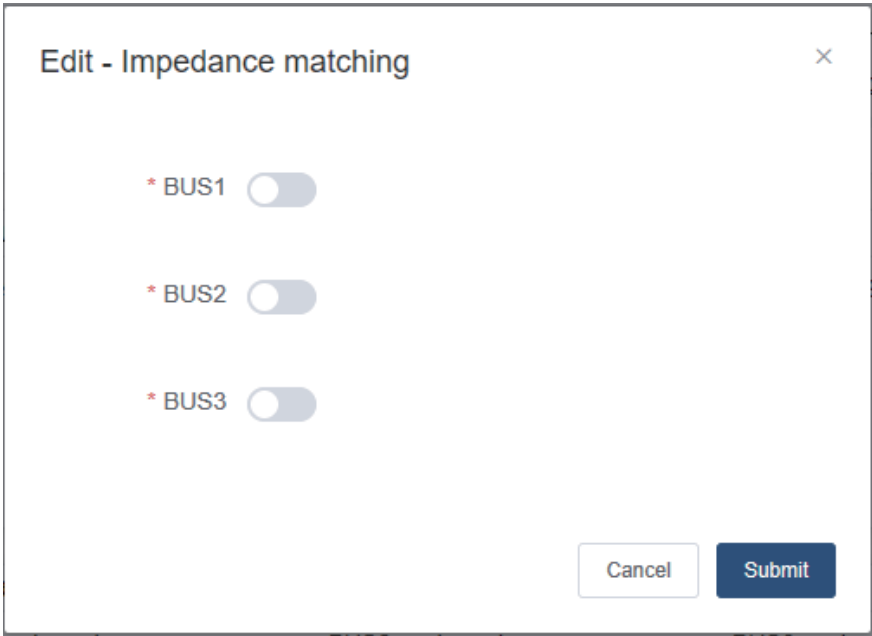

This pane displays the status of impedance matching. You can click "Edit" to enable or disable impedance matching for buses.

2.3.1.7 System Operation

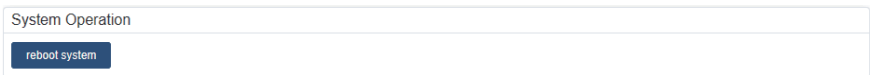

Click "reboot system" to soft reboot the gateway.

2.3.2 VRF Bacnet Console

VRF BACnet debugging: You can use the BACnet protocol to obtain the list of names and positions of devices on the BACnet after the current gateway changes the protocol. Position data is updated in real time.

System Configuration | VRF Bacnet Console | admin

System Configuration | VRF Bacnet Console

Port 2

- System 0
 - idu-19-2-0-0
 - idu-19-2-0-1
 - idu-19-2-0-2
 - idu-19-2-0-3
 - idu-19-2-0-4
 - idu-19-2-0-5
 - idu-19-2-0-6
 - idu-19-2-0-7
 - idu-19-2-0-8
 - idu-19-2-0-9
 - idu-19-2-0-10
 - idu-19-2-0-11
 - idu-19-2-0-12
 - idu-19-2-0-13
 - idu-19-2-0-14

idu-19-2-0-0

Name	Object	Present value
Malfunction Code	AI 7	0
Room Temperature	AI 6	7.5
EXV	AI 18	75
Mode	AI 1	0
AutoMode	BI 3	0
FanGear	AI 2	1
AutoFan	BI 4	0
Setpoint	AI 3	6.5
Cool Setpoint	AI 4	6.5
Heat Setpoint	AI 5	6.5

2.3.3 User

User management: You can add, delete, and modify web users.

User / User Management | admin

System Configuration | User Management

User Management [Add User](#)

UserID	User Name	Administrator	Operation
1	admin	Yes	Edit

Total 1 | 10/page | < 1 > | Go to 1

3 IP Address Resetting

If you forgot the IP address and cannot open the Gateway web page, do as follows to reset the IP address:

Power off the Gateway, and short circuit the X0Y0E and X1Y1E ports (connect the X ends together, the Y ends together, and the E ends together, respectively).

Power on the Gateway. When the running indicator blinks normally, the Gateway IP address is reset to 192.168.1.8.

4 Installation Instructions

4.1 Product Introduction

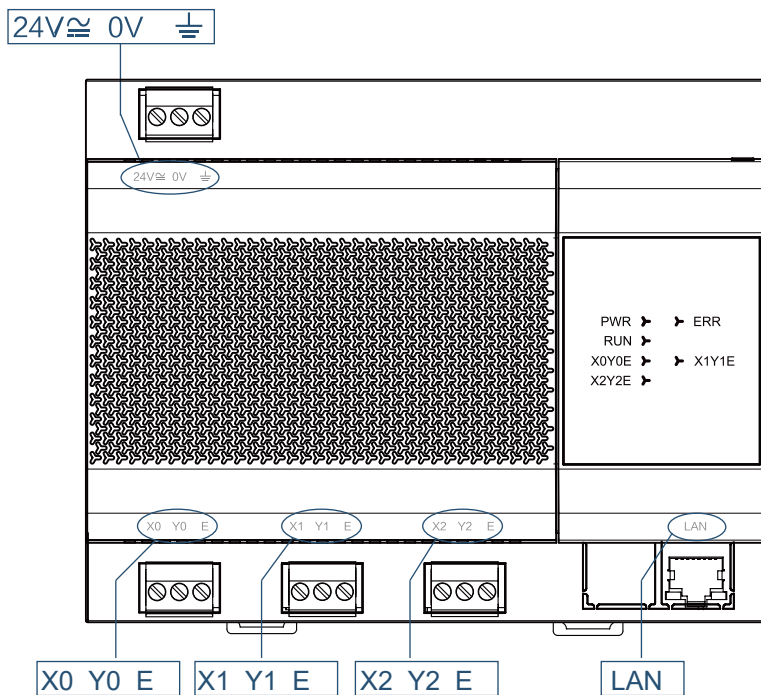

4.2 Product Dimensions

Unit: mm

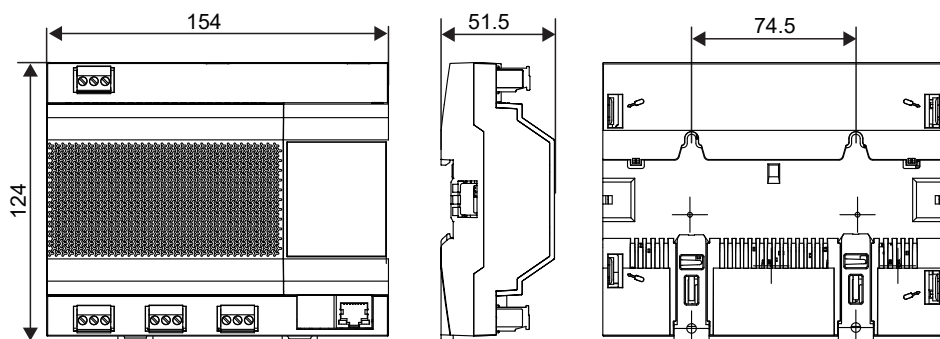

4.3 Installation Accessories

Please check that you have all the following parts.

No.	Name	Quantity	Remarks
1	Self-tapping screw	4	ST4*20
2	Plastic expansion pipe	4	For installing the controller onto the wall
3	3-pin black terminal	3	For communication
4	3-pin gray terminal	1	For connecting the power supply

4.4 Installation Method

4.4.1. Installing the Guide Rail

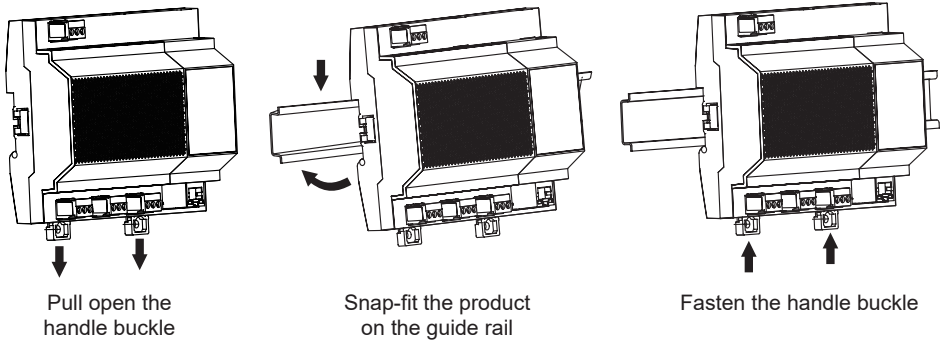

4.4.2. Mounting the Device on the Wall

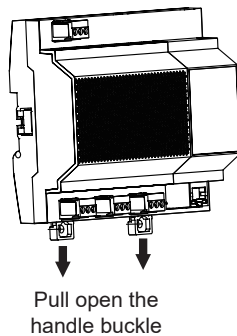

Plastic expansion pipe

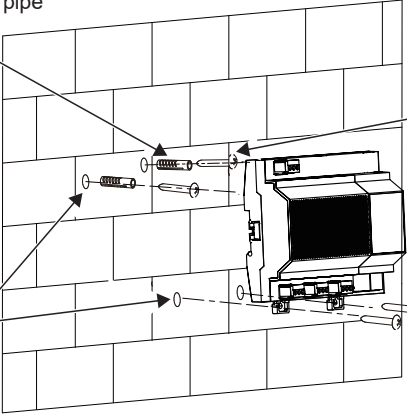

Phillips head screw ST4*20
(This fixing screw is pre-inserted into the wall and the distance from the highest position of the nut to the wall is 5.5 mm)

Drill with a 6mm drill bit, with a drill depth of no less than 30mm

Phillips head screw ST4*20

