

INSTALLATION & OWNER'S MANUAL

Universal Wired Remote Controller



Model Number:
WC-02

IMPORTANT NOTE:

Please read this manual carefully before installing or operating your wired remote controller. Make sure to save this manual for future reference.

That's better. That's Actron.



Table of Contents

Installation and Owner's Manual

1.	Safety Precaution.....	3
2.	Installation Components.....	4
3.	Installation Method.....	5
4.	Specification.....	10
5.	Wired Controller Features and Functions.....	11
6.	Wired Controller Display.....	12
7.	Wired Controller Buttons.....	13
8.	Preparatory Operation.....	14
9.	Operation.....	15
10.	Timer Functions	20
11.	Weekly Timer.....	23
12.	Fault Alarm Handling	30

- This manual gives detailed description of the precautions that should be brought to your attention during operation.
- To ensure the correct service of the wired controller read this manual carefully before using the unit.
- Keep this manual after reading for future reference.

WARNING

- Carefully read the Safety Precautions before installation. Adhere to this installation manual.
- Only trained and qualified HVAC technicians should install, repair and service this air conditioning unit, strictly follow the installation instructions set forth in this manual. Improper installation may result in electrical shock, short circuit, leaks, fire or other damage to the equipment and personal property.
- Reinstallation must be performed by a qualified service technician.

WARNINGS FOR PRODUCT USE

- **DO NOT** install the unit in a place vulnerable to leakage of flammable gases. If flammable gases leak or linger around the wired controller, fire may occur.
- **CODES, REGULATIONS, AND STANDARDS**
The installer/contractor assumes responsibility to ensure that the installation complies with the relevant council, state/federal codes, regulations and building code standards. All electrical wiring must be in accordance with current electrical authority regulations and all wiring connections to be as per the electrical diagram/s provided with the unit.

FOR COMPLIANCE WITH
QUEENSLAND ELECTRICAL SAFETY
REGULATIONS 2002
This refers to electrical works only



**MUST BE INSTALLED BY A
LICENSED ELECTRICIAN**

Read Safety Precautions Before Installation

Thank you for purchasing this air conditioner. This manual will provide you with information on how to operate, maintain, and troubleshoot your air conditioner. Following the instructions will ensure the proper function and extended lifespan of your unit.

Please pay attention to the following signs:



WARNING

Failure to observe a warning may result in death or serious injury. The appliance must be installed in accordance with national regulations.



CAUTION

Failure to observe a caution may result in injury or equipment damage.

This manual is a controlled document which contains confidential and proprietary information. Distribution, modification, copying and/or reproduction are prohibited without written consent from ActronAir

Product design and specifications are subject to change without prior notice for product improvement.

No.	Name	Qty	Remarks
1	Wired controller	1	-
2	Installation and owner's manual	1	-
3	Screws	3	M4X20 (for mounting on the wall)
4	Wall plugs	3	For mounting on the wall
5	Screws	2	M4X25 (for mounting on switch box)
6	Plastic screw bars	2	For fixing on switch box
7	Battery	1	CR2032
8	connecting cables	2	-

Precaution for the installation of the wired controller

1. This manual provides the installation method for the wired controller. Please refer to the wiring diagram in this installation manual to wire the wired controller with the indoor unit.
2. The wired controller uses extra-low voltage (ELV) only. **DO NOT** connect to low voltage 230VAC circuits or wiring as damage to wired controller will result. Maintain correct separations between ELV wiring and other 230VAC mains wiring.
3. The shielded wire of the wired controller must be properly grounded, see wiring diagram.
4. Upon finalising the wired controller connection, do not use an ohmmegger test to check the insulation.



WARNING

KEEP OUT OF REACH OF CHILDREN

Contains button or coin cell battery. Hazardous if swallowed. Swallowing can lead to chemical burns, perforation of soft tissue and death. Severe burns can occur within 2 hours of ingestion. Seek medical attention immediately.



1. Wired remote controller dimensions

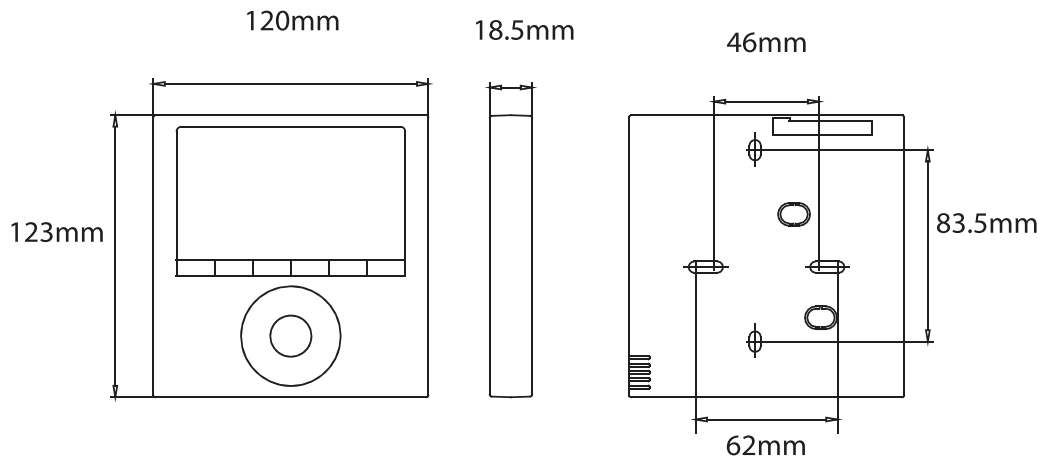

Fig 3.1

3. Installation Method

Wired Remote Controller

2. Wiring Connection Diagram for Cassettes & Ducted

1. Connect wired controller to indoor unit mainboard using the connecting cables included. Connect the adaptor cable (smaller cable) first to the indoor main board. Then connect the wired controller using the longer connecting cable.

Fig 3.2

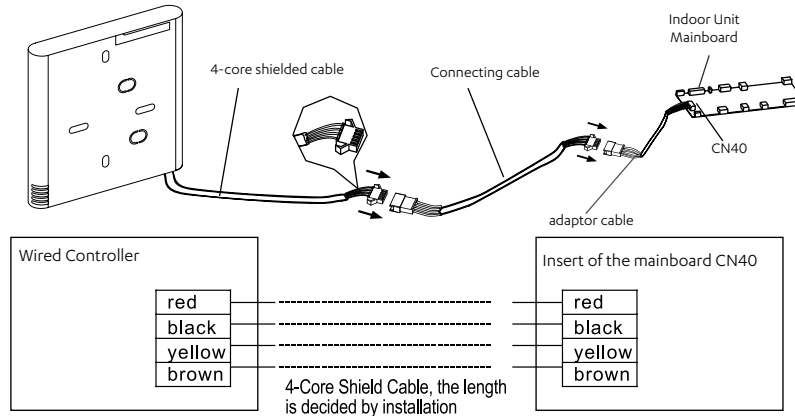

3. Wiring Connection For Wall Splits

1. Open the front panel , identify the multi function box (See Fig.3.3.1).

Fig 3.3.1

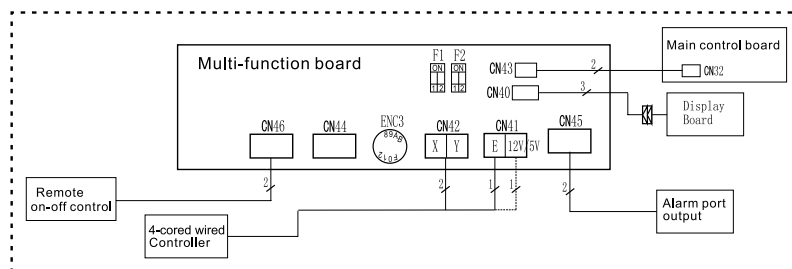

When connecting to 4-core wired controller:

- 12V = Red
- E = Black
- Y = Yellow
- X = Brown

2. Cut the terminal of the longer connection cable (See Fig 3.3.2).
3. Connect the four wires to each of the pins in the multi function board as follows:
The red wire on wire controller connect to 12V/5V pin on multi function board; black wire to E pin; yellow wire to Y pin; brown wire to X pin. (See Fig.3.3.1).

Fig 3.3.2

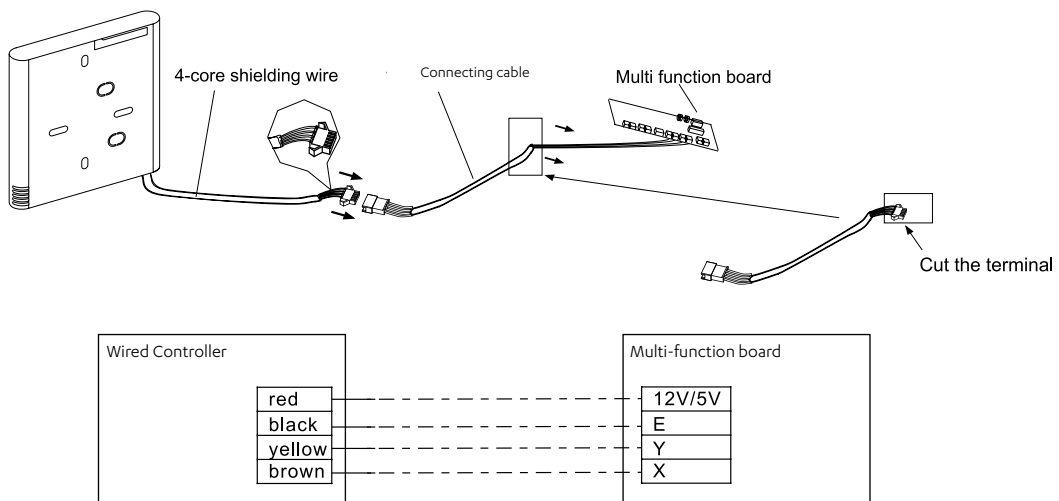

4. Wire controller - Removing the upper part

- Insert a flat screwdriver into the slots in the lower part of the wire controller (2 places).
- Remove the upper part of the wire controller (Fig.3.4)

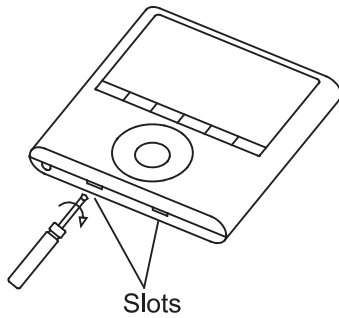

NOTE

The PCB is mounted in the upper part of the wired controller. Be careful not to damage the board with the screwdriver.

5. Fasten the wire controller back plate

- For surface mounting, fasten the back plate on the wall with the 3 screws (M4x20) and plugs. (Fig.3.5)

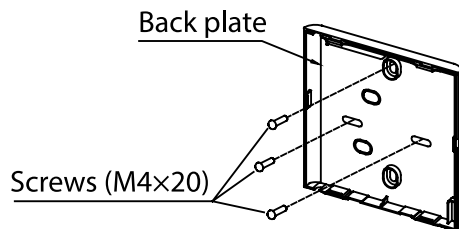

NOTE

Place on a flat surface. Be careful not to distort the wire controller's back plate by over-tightening the mounting screws.

6. Battery installation

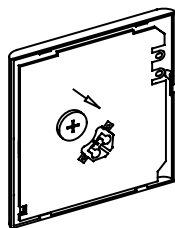

Fig 3.7

- Place the battery in the unit and ensure the positive side of the battery is in accordance with the polarity markings. (See Fig.3.7)
- Set the correct time before operating. Batteries in the wired controller can maintain the correct time during a power failure. When the power is restored and the displayed time is not correct, replace the battery.

7. Wiring the indoor unit

There are three methods:

1. from the rear;
2. from the bottom;
3. from the top;

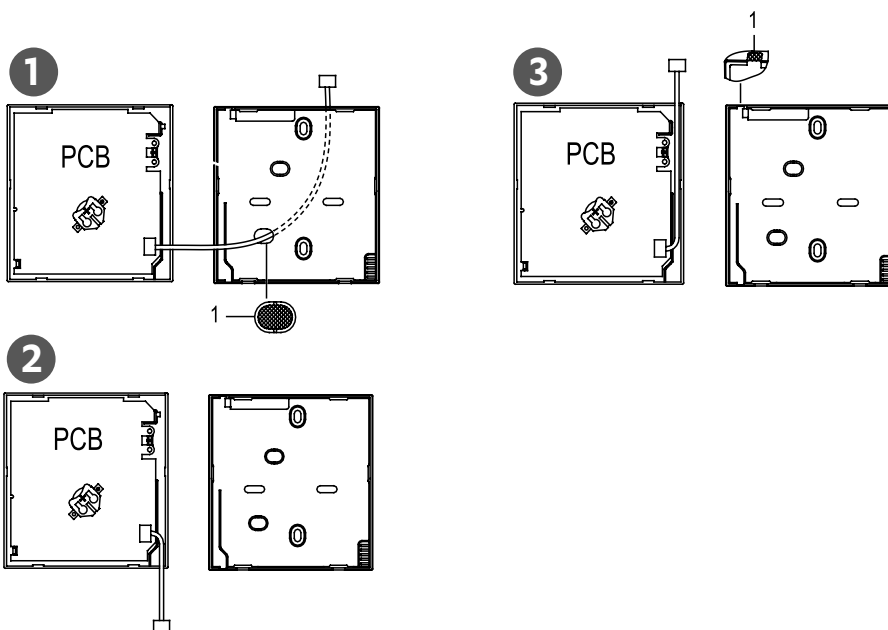

4. Notch the part for the wiring to pass through with a nipper tool.

NOTE

DO NOT allow water to enter the remote control. Use a water loop and silastic to seal the wires.

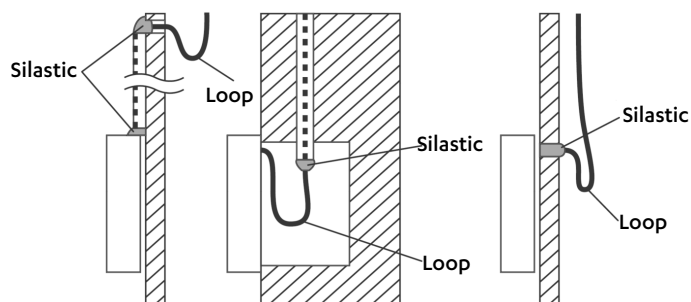

Fig 3.8

8. Reattach the wire controller's upper part

- While adjusting and mounting the upper case, avoid clamping the wiring during installation. (Fig 3.9)

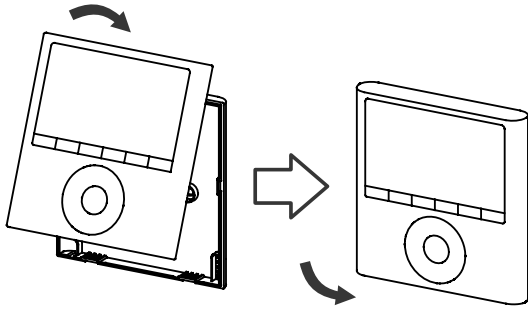

Fig 3.9

IMPORTANT: All the pictures in this manual are for illustration purposes only.

Your wire controller may differ slightly.

Wiring Specifications

Input Voltage	DC 12V
Ambient Temperature	5°C~43°C
Ambient Humidity	RH40%~RH90%

Wiring Specifications

Wiring Type	Size	Total Length
Shielded PVC or cable	0.75mm ²	≤ 20m
	1.5mm ²	≤ 50m

Feature and Function of the Wired Controller

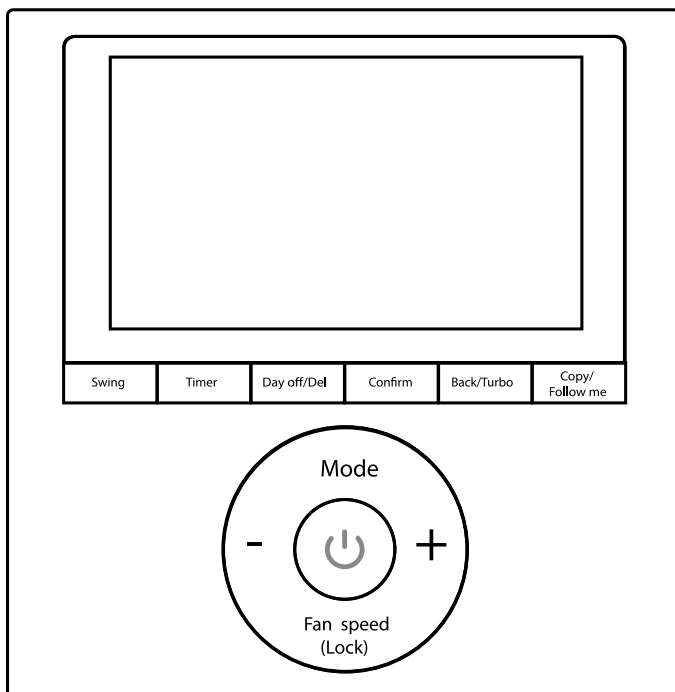

Feature:

- LCD display.
- Malfunction code display: displays the error code (helpful for servicing)
- 4-way wire layout design.
- Room temperature display.
- Weekly Timer

Function:

- Mode: choose Auto-Cool-Dry-Heat-Fan
- Fan speed: Auto-Low-Med-High
- Swing (on Wall Split and Cassettes)
- Timer ON/OFF
- Temp setting
- Weekly Timer
- Follow me
- Child Lock
- LCD Display
- Clock
- Elevating Panel Function (on Cassettes only)

Wired Controller Display

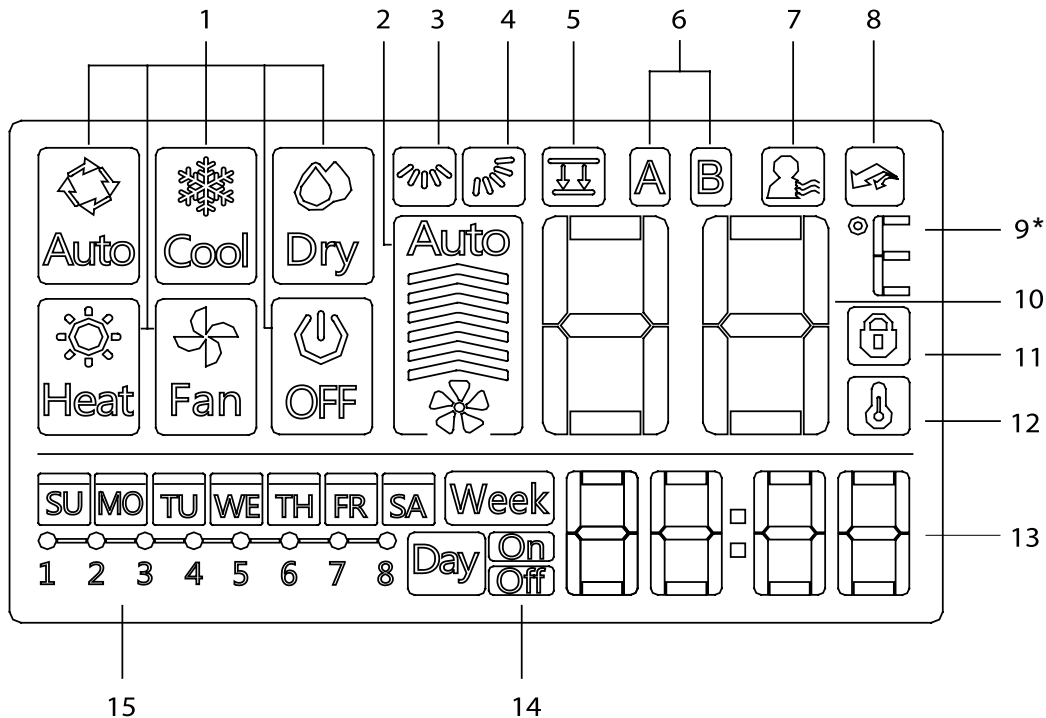

- | | |
|---|--|
| 1. Operation mode indicator | 8. Turbo/Auxiliary Heat function indicator |
| 2. Fan speed indicator | 9. °C indicator * |
| 3. Left-right swing indicator | 10. Temperature display |
| 4. Up-down swing indicator | 11. Lock indicator |
| 5. Elevating Panel Function indicator | 12. Room temperature indicator |
| 6. Main unit and secondary unit indicator | 13. Clock display |
| 7. Follow me function indicator | 14. On/Off timer |
| | 15. Timer display |

* To change temperature indicator display from Fahrenheit to Celsius (or vice versa), hold the last two buttons on the control "Back/Turbo" and "Copy/Follow me" at the same time until it changes whilst the unit is in the **ON** position.

Wired Controller Buttons

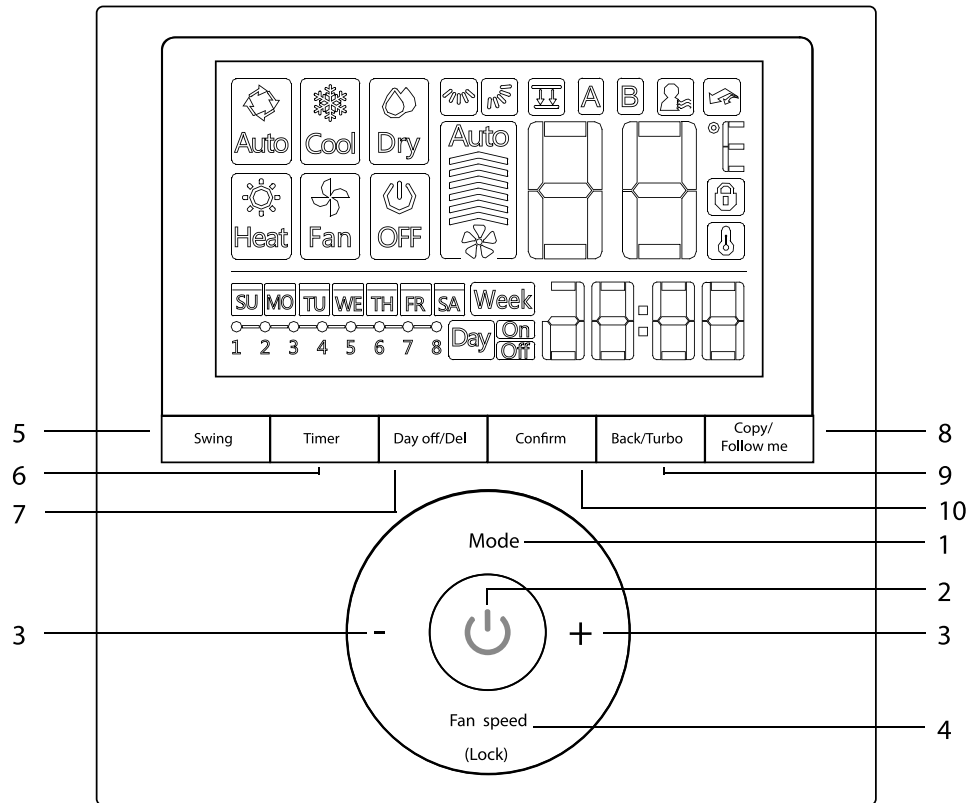

- | | |
|--------------|-------------------|
| 1. Mode | 6. Timer |
| 2. Power | 7. Day Off/Del |
| 3. Adjust | 8. Copy/Follow me |
| 4. Fan Speed | 9. Back/Turbo |
| 5. Swing | 10. Confirm |

Set the current Day and Time

1. Press **TIMER** for 3s or more. The timer displays flashes.

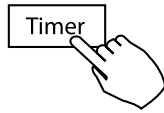

2. Press + or - to set the date. The selected date flashes.

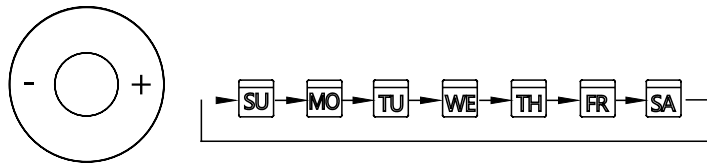

3. Date setting is complete and the time setting is ready after pressing **TIMER** or if nothing is pressed in 10 seconds.

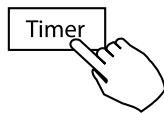

4. Press + or - to set the current time. Press repeatedly to adjust the current time in 1 minute increments. Press and hold to adjust the current time.

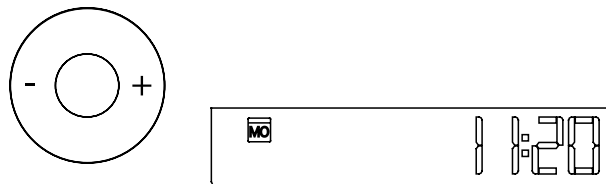

ex. Monday AM 11:20

5. The setting is complete after pressing **TIMER** or if no button is pressed for 10 seconds.

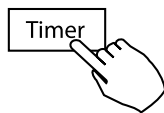

To Start/Stop Operation

Press the Power Button



To Set The Operation Mode (operating mode setting)

Press **MODE** to set the operation mode.

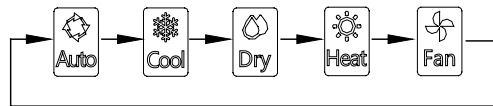
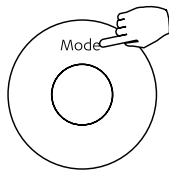

Room Temperature Setting

Press + or - to set the room temperature.

Indoor Setting Temperature Range: (17~30°C).

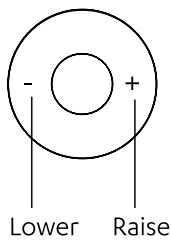

Fan Speed Setting

Press **FAN SPEED** to set the fan speed.

NOTE: This function is unavailable in the AUTO or DRY modes

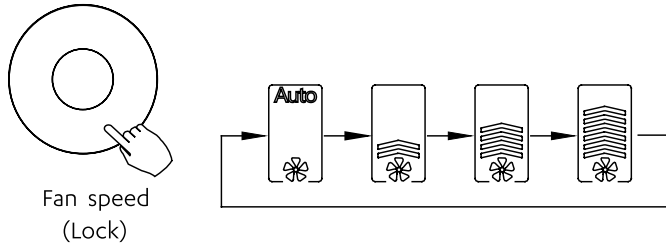

Room Temperature Sensor Selection

Press **FOLLOW ME** to select whether the room temperature is detected at the indoor unit or at the wired controller.

NOTE: When the **FOLLOW ME** function indication  appears, the room temperature is detected at the wire remote controller.

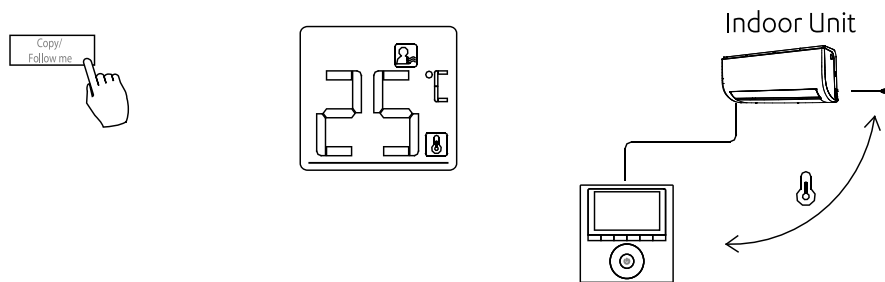

Child Lock Function

Press **LOCK** for 3 seconds to activate the **CHILD LOCK** feature and lock all buttons on the wired controller. Press again for 3 seconds to deactivate.

NOTE: When the child lock function is activated, the lock image  appears.

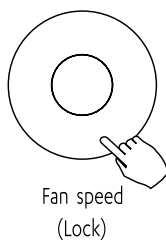

Keypad Tone Setting

Press **SWING** and **TIMER** simultaneously for 3 seconds to disable the keypad tone.
Press the buttons again for 3 seconds to enable the keypad tone.

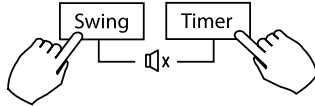

Turbo

- Press **TURBO** to activate/deactivate the Turbo function.
The turbo function sets the unit to reach the user's present temperature in the shortest amount of time possible.
- When the user presses **TURBO**, the unit sets to the highest fan speed setting to jump-start the cooling / heating process.

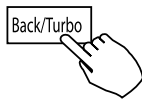

Elevating Panel Function (only for Cassette models)

1. When the unit is off Press the **MODE** button long to activate the lift panel function.
The  mark will flash.
2. Press the button + and - to control the lift and drop of the panel.
Pressing the + button can stop the panel, while it is dropping.
Pressing the - button can stop the panel, while it is lifting.

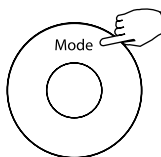

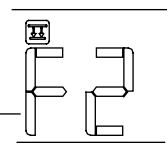

The F2 mark appears when the panel is adjusted.



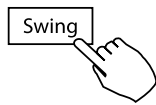

Swing Function (for Cassette models)

Up-Down airflow direction and swing

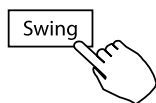

- Use **SWING** to adjust the up and down airflow direction
 1. Every time the user presses **SWING**, the louvre swings six degrees.
 2. Press and hold **SWING** for 2 seconds, it changes to the **UP-DOWN SWING** mode. Press **SWING** again to stop. When the Up-Down swing function is activated, the  mark appears. (Not applicable to all the models)
- The operation can refer to the following instructions for the unit with four Up-Down louvres can be operated individually.
 1. Press the **SWING** button to activate the Up-Down adjusting louvre function. The  mark will flash. (Not applicable to all the models)



2. Pressing the button "+" or "-" can select the movement of four louvres. Each time you push the button, the wire controller select in a sequence that goes from: (the  icon means the four louvres move at the same time.)

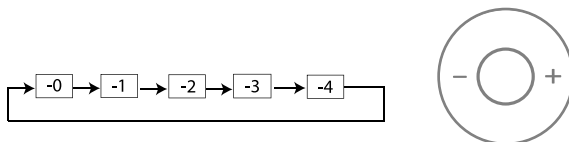

3. And then use **SWING** button to adjust the Up-Down airflow direction of the selected louvre.

Swing Function (for Wall Split models)

1. Up-Down swing

Press the Swing button to start up-down swing function.

Press it again to stop.

When the Up-Down swing function is activated, the  mark appears.

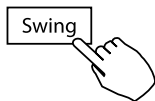

2. Left-Right swing

Press the Swing button long to start Left-Right swing function.

Press it again to stop.

When the Left-Right swing function is activated, the  mark appears.

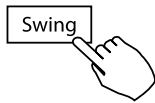

Timer Overview

Weekly Timer



Use to set the operating times for each day of the week.

On Timer



Use to start the air conditioner operation.

The timer operates and the air conditioner operation starts after the time has passed.

Off Timer



Use to stop the air conditioner operation.

The timer operates and the air conditioner operation stops after the time has passed.

On and Off Timer



Use to start and stop the air conditioner operation.

The timer operates and the air conditioner operation starts and stops after the time has passed.

To Set the On or Off Timer

1. Press **Timer** to select the **Day On** or **Day Off** button.

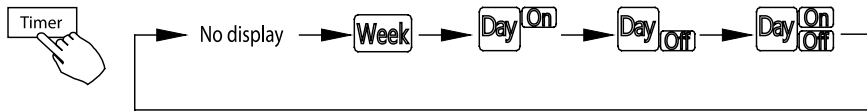

2. Press **Confirm** and the Clock display flashes.

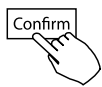

3. Press + or - to set the time. After the time is set, the timer starts or stops automatically.

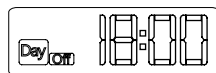
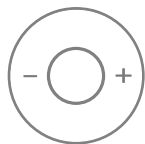

ex. Off timer set at PM 6:00

4. Press **Confirm** again to finish the settings.

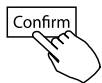

To Set the On and Off Timer

1. Press **Timer** to select the  button.

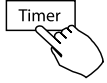

2. Press **Confirm** and the Clock display flashes.

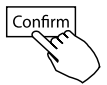

3. Press the button + or - to set the **On Timer** and then press **Confirm**.

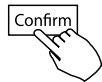
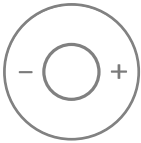

4. Press the button + or - to set the **Off Timer**.

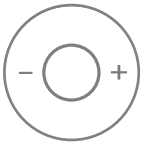

5. Press **Confirm** to finish the setting.

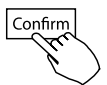

1. Weekly Timer Setting

Press **Timer** to select the **Week** and press confirm.

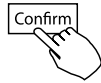
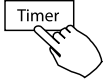

2. Day Of The Week Setting

Press the button + or - to select the day of the week and then press **Confirm**.

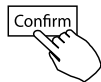
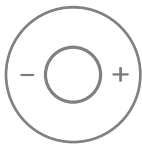

3. Event timer setting

Press the button + or - to select the setting time.

The setting time, mode, temperature and fan speed appear on the LCD.

Press **Confirm** to enter the setting time process.

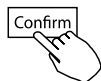
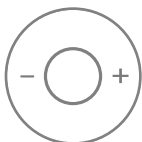

11. Weekly Timer

Wired Remote Controller

IMPORTANT

Up to 8 scheduled events can be set on one day. Various events can be scheduled in either MODE, TEMPERATURE and FAN speeds.

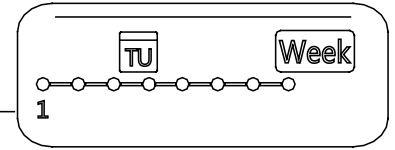

ex. Tuesday time scale 1

4. Timer Setting

Press + and - to set the time then press **Confirm**.



NOTE: To set the off time event refer to step 8.

5. Operation Mode Setting

Press + and - to set the operation mode then press **Confirm**.

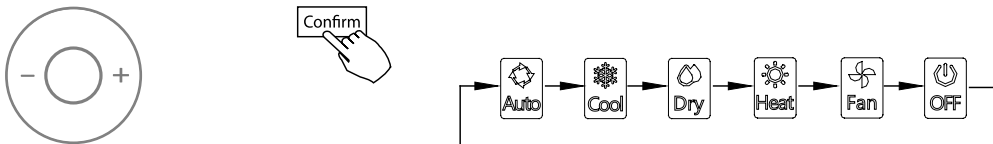

6. Room Temperature Setting

Press + and - to set the room temperature then press **Confirm**.

NOTE: This setting is unavailable in the **FAN** or **OFF** modes.



7. Fan Speed Setting

Press + and - to set the fan speed then press **Confirm**.



NOTE: This setting is unavailable in the AUTO, DRY or OFF modes.

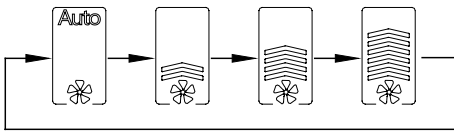

8. Off Mode Setting

Press + and - to set the operation off then press **Confirm**.

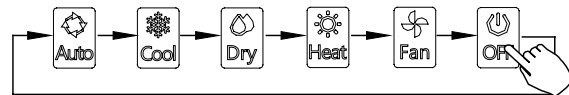

9. Different Scheduled Events

Different scheduled events can be set by repeating **steps 3** through **7**.

10. Additional Days

Additional days, in a one week period, can be set by repeating **steps 3** through **8**.

NOTE: The weekly timer setting can be returned to the previous step by pressing **BACK**. The current setting is restored. The controller will not save the weekly timer settings if there is no operation within 30 seconds.

To Start

Press Timer to select the **Week**, and then the timer starts automatically.

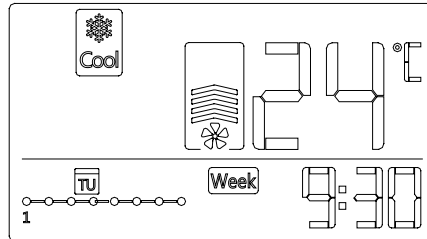
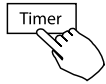

ex.

To Cancel

Press Power to cancel the timer mode.



The timer mode can also be cancelled by changing the timer mode using Timer.

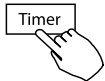

To Set The Day Off (for a holiday)

1. After setting the weekly timer, press **Confirm**.

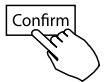

2. Press **+** or **-** to select the day of the week.

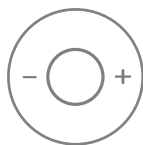

To Create An Off Day

- Press **DAY OFF** to create an off day.

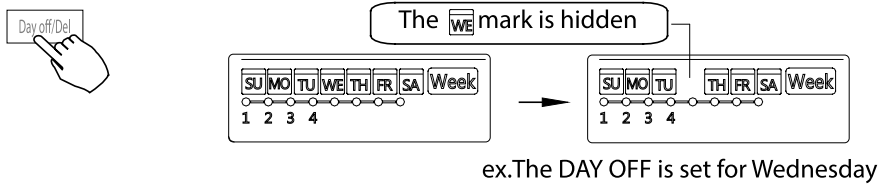

- Set the **DAY OFF** for other days by repeating the **steps 2** and **3**.
- Press **BACK** to revert to the weekly timer.

To Create An Off Day

- To cancel, follow the same procedures used for setup
NOTE: The DAY OFF setting is cancelled automatically after the set day has passed.

To Copy Out The Setting

Copy out the setting in one day into the other day.

- A scheduled event, made once, can be copied to another day of the week. The scheduled events of the selected day of the week will be copied. The effective use of the copy mode ensures the ease of reservation making.

- In the weekly timer, press **Confirm**.



- Press + or - to select the day to copy from.

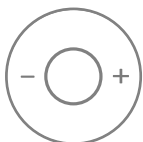

To Copy Out The Setting (continued)

3. Press **COPY**, the letters **CY** appear on the LCD.

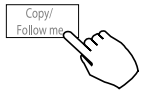

4. Press + or - to select the day to copy to.

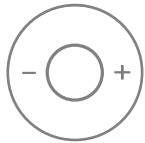

4. Press + or - to select the day to copy to.

5. Press **COPY** to confirm.

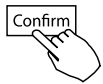

The **WE** mark flashes quickly

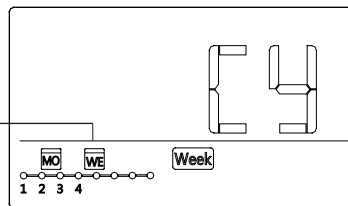

ex. Copy the setting of Monday to Wednesday

6. Other days can be copied by repeating steps 4 and 5

7. Press **Confirm** to confirm the settings.

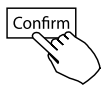

8. Press **BACK** to revert to the weekly timer



Delete The Time Scale In One Day

To Delete the time scale in one day.

1. During the weekly timer setting, press **Confirm**.

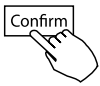

2. Press + and - to select the day of the week and then press **Confirm**.

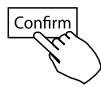
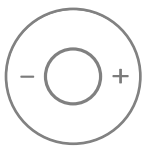

3. Press + and - to select the setting time want to delete.

The setting time, mode, temperature and fan speed appear on the LCD.

The setting time, mode, temperature and fan speed can be deleted by pressing the **DEL** (day off).

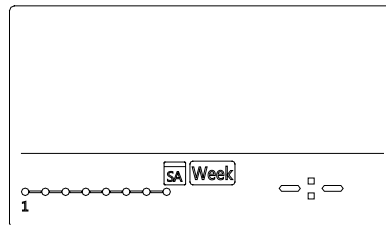
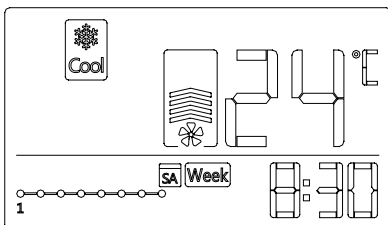
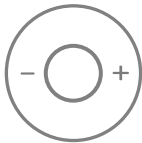

ex. Delete the time scale 1 in Saturday

Error Codes

Error Codes	Causes
E0	Phase sequence error or phase malfunction
E1	Communication malfunction between indoor and outdoor units
E2	T1 sensor malfunction
E3	T2A sensor malfunction
E4	T2B sensor malfunction
E5	T3 or T3 or TP sensor malfunction
E6	Zero check malfunction
E7	Indoor EERROM malfunction
E8	Fan controller out of control
E9	Communication malfunction between main PCB and display board
EA	Compressor overload (4 times)
EB	IPM mould malfunction
EC	Air clean malfunction
ED	Outdoor malfunction protection
EE	Full-water malfunction
EF	Other fault
F0	Communication error between wired controller and indoor unit
F1	Elevating Fascia panel not closed
P0	Evaporator temperature protection
P1	Enter anti-code or defrost mode
P2	Condenser temperature protection
P3	Compressor temperature protection

Please check the indoor unit's error display and review the owner's manual if other error codes appear.

Error Codes

Error Codes	Causes
P4	Discharge pipe temperature protection
P5	Discharge high pressure protection
P6	Discharge low pressure protection
P7	Over-voltage protection
P8	Compressor overload protection
P9	Reserve code
PA	Reserve code
PB	Reserve code
PC	Reserve code
PD	Reserve code
PE	Reserve code
PF	Other fault

Please check the indoor unit's error display and review the owner's manual if other error codes appear.



ActronAir

That's better. That's Actron.

actronair.com.au

1300 522 722