

ECOFLEX MINI VRF R-32 SERIES

Four-way Compact Cassette

Owner's Manual



Model Numbers

MCC-015CS
MCC-022CS
MCC-028CS
MCC-036CS
MCC-045CS
MCC-056CS
MCC-063CS



CAUTION:

The system is charged with flammable refrigerant, safety checks are necessary to ensure that the risk of ignition is minimised.



Table of Contents

01. Preface	3
01. Safety Warning	4
01.01. Warning Signs	4
01.02. Safety Precautions	5
01.03. Electric Safety Requirements	6
01.04. Appendix	7
02. Operation	10
02.01. Operation Precautions	10
02.02. Optimum Operation	11
03. Symptoms That Are Not Faults	12
04. Display panel	14
05. Cleaning and Maintenance	14
05.01. Safety Warning	14
05.02. Cleaning the Air Filter	15
05.03. Cleaning Air Outlets and Exteriors Panels	16
05.04. Maintenance	17
06. Maintenance Frequency Checklist	18

01. Preface

Dear users,

Thank you for purchasing and using our product. Please read this manual carefully before you install, use, maintain or troubleshoot this product so that you can familiarize yourself with the product and use it correctly.

For Outdoor Units or other Indoor Units, please refer to the applicable installation & owner's manuals provided with them.





For detailed operation of auxiliary control devices, such as wired, remote and centralized controllers, please refer to their instructions.

To ensure the correct installation and operation of the product, the following instructions are provided:

- To ensure the correct and safe operation of the product, please strictly follow the requirements listed in this manual.
- All figures and contents in this manual are for reference only. Due to continuing product improvement, the specifications are subject to change without notice.
- Regular cleaning and maintenance of the product are required for intended performance and long service life. Each year before using the air conditioner, please contact your local dealer, and we will assign professionals to provide paid services of cleaning, maintenance, and inspection.
- Please retain this manual for future reference.



01. Safety Warning

Please thoroughly read and ensure that you fully understand the safety precautions (including the signs and symbols) in this manual, and follow relevant instructions during use to prevent damage to health or property.

	WARNING	This symbol shows that this appliance used a flammable refrigerant. If the refrigerant is leaked and exposed to an external ignition source, there is a risk of fire.
	CAUTION	This symbol shows that the operation manual should be read carefully.
	CAUTION	This symbol shows that a service personnel should be handling this equipment with reference to the installation manual.
	CAUTION	This symbol shows that information is available such as the operating manual or installation manual.

01.01. Warning Signs

Different marks are used to indicate the levels of hazard severity. Please follow the instructions and ensure safe operation:

	DANGER	Failure to observe the warning will result in severe personal injury or death.
	WARNING	Failure to observe the warning could result in severe personal injury or death, property damage, or electrical or fire hazards.
	CAUTION	Failure to observe the warning could result in minor personal injury, product or property damage, or other unsafe situations.
	NOTE	Useful operation and maintenance information.

Warning Contents



Ensure Proper Grounding



Professional Only

Prohibition signs



No Flammable Materials



No Strong Current



No Open Fire



No Acid or Alkali Materials

01.02. Safety Precautions

DANGER

During thunderstorms, disconnect the main power switch. Otherwise, lightning may damage the unit.

In the event of refrigerant leakage, smoking and open flames are prohibited. Disconnect the main power switch immediately, open windows to allow ventilation, keep away from the leakage point, and contact your local dealer or technical support to request a professional repair.

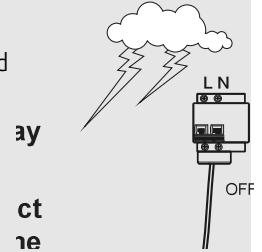

WARNING

Air conditioner installation must comply with local standards and electrical codes, and relevant instructions in this manual.

Do not use any liquid cleanser, liquefied cleanser, or corrosive cleanser to wipe this unit or spray water or other liquids on the unit. Otherwise, the plastic parts of the unit will become damaged and an electrical shock may occur. Disconnect the main power switch before cleaning and maintenance to avoid accidents.

Ask a professional to remove and reinstall the air conditioner. Ask a professional for maintenance and repair assistance.

This air conditioner is classified as an “appliance which is not accessible to the general public”.

The Indoor Unit shall be placed at a height not accessible to children, at least 2.3m above the ground.

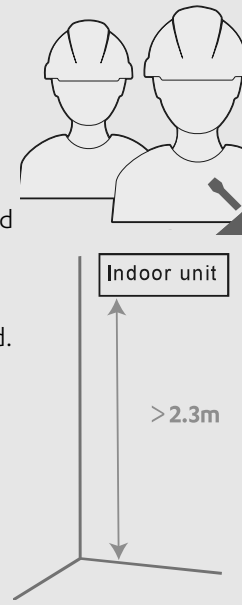

CAUTION

This appliance is not intended for use by persons (including children) with reduced physical, sensory or mental capabilities, or lack of experience and knowledge, unless they have been given supervision or instruction concerning use of the appliance by a person responsible for their safety.

Children should be supervised to ensure that they do not play with the appliance.

The units are partial unit air conditioners, complying with partial unit requirements of this International Standard, and must only be connected to other units that have been confirmed as complying to corresponding partial unit requirements of this International Standard.

01.03. Electric Safety Requirements

WARNING

- The air conditioner shall be installed according to the local wiring specifications. Wiring work must be completed by qualified electricians.
- All wiring work must comply with electrical safety specifications.
- The air conditioner must be well grounded. Specifically, the main switch of the air conditioner must have a reliable grounding cable.
- Before contacting wiring devices, cut off all the power supplies.
- The user **MAY NOT** disassemble or repair the air conditioner. Doing so can be dangerous. In the event of a fault, immediately cut off the power and contact your local dealer or technical support.
- A separate power supply that meets the rated parameter values must be provided for the air conditioner.
- The fixed wiring to which the air conditioner is connected must be equipped with a power cut-off device that meets the wiring requirements.
- To avoid danger, a damaged power cable must be replaced by professionals from the maintenance department or a similar department of the manufacturer.
- The air conditioner's circuit board (PCB) is designed with a fuse to provide overcurrent protection.
- The specifications of the fuse are printed on the circuit board.
- NOTE: For the units with R-32 refrigerant, only the blast-proof ceramic fuse can be used.

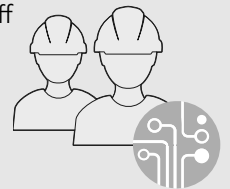
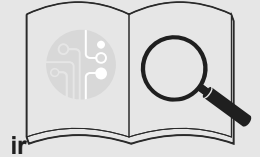

CAUTION

Always ground the main power switch.

Do not use a damaged power cable and replace it if it is damaged.

When the air conditioner is used for the first time or is in a power-off state for a long time, it needs to be connected to the power supply and warmed up for at least 12 hours before use.

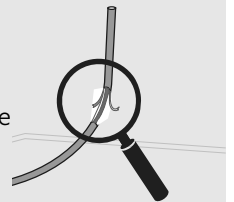

01.04. Appendix

WARNING

The following applies to R-32 refrigerant systems.

- Prior to beginning work on systems containing flammable refrigerants, safety checks are necessary to ensure that the risk of ignition is minimized.
- For repair to the refrigerating system, the following precautions shall be complied with prior to conducting work on the system.
- Work shall be undertaken under a controlled procedure so as to minimise the risk of a flammable gas or vapour being present while the work is being performed.
- All maintenance staff and others working in the local area shall be instructed on the nature of work being carried out. Work in confined spaces shall be avoided. The area around the workspace shall be sectioned off. Ensure that the conditions within the area have been made safe by control of flammable material.
- Ensure that the leak detection equipment being used is suitable for use with flammable refrigerants, i.e. non-sparking, adequately sealed or intrinsically safe.
- If any hot work is to be conducted on the refrigeration equipment or any associated parts, appropriate fire extinguishing equipment shall be available to hand. Have a dry powder or CO² fire extinguisher adjacent to the charging area.
- No person carrying out work in relation to a refrigeration system which involves exposing any pipe work that contains or has contained flammable refrigerant shall use any sources of ignition in such a manner that it may lead to the risk of fire or explosion.
- All possible ignition sources, including cigarette smoking, should be kept sufficiently far away from the site of installation, repairing, removing and disposal, during which flammable refrigerant can possibly be released to the surrounding space.
- Prior to work taking place, the area around the equipment is to be surveyed to make sure that there are no flammable hazards or ignition risks. "No Smoking" signs shall be displayed.
- Ensure that the area is in the open or that it is adequately ventilated before breaking into the system or conducting any hot work. A degree of ventilation shall continue during the period that the work is carried out. The ventilation should safely disperse any released refrigerant and preferably expel it externally into the atmosphere.
- Where electrical components are being changed, they shall be fit for the purpose and to the correct specification. At all times the manufacturer's maintenance and service guidelines shall be followed. If in doubt consult the manufacturer's technical department for assistance.
- The following checks shall be applied to installations using flammable refrigerants:
 1. the charge size is in accordance with the room size within which the refrigerant containing parts are installed;
 2. the ventilation machinery and outlets are operating adequately and are not obstructed;
 3. if an indirect refrigerating circuit is being used, the secondary circuit shall be checked for the presence of refrigerant;
 4. marking to the equipment continues to be visible and legible. Markings and signs that are illegible shall be corrected;
 5. refrigeration pipe or components are installed in a position where they are unlikely to be exposed to any substance which may corrode refrigerant containing components, unless the components are constructed of materials which are inherently resistant to being corroded or are suitably protected against being so corroded.
- Repair and maintenance to electrical components shall include initial safety checks and component inspection procedures.

- If a fault exists that could compromise safety, then no electrical supply shall be connected to the circuit until it is satisfactorily dealt with. If the fault cannot be corrected immediately but it is necessary to continue operation, an adequate temporary solution shall be used. This shall be reported to the owner of the equipment so all parties are advised.
- Initial safety checks shall include:
 1. that capacitors are discharged: this shall be done in a safe manner to avoid possibility of sparking;
 2. that no live electrical components and wiring are exposed while charging, recovering or purging the system;
 3. that there is continuity of earth bonding.
- During repairs to sealed components, all electrical supplies shall be disconnected from the equipment being worked upon prior to any removal of sealed covers, etc. If it is absolutely necessary to have an electrical supply to equipment during servicing, then a permanently operating form of leak detection shall be located at the most critical point to warn of a potentially hazardous situation.
- Particular attention shall be paid to the following to ensure that by working on electrical components, the casing is not altered in such a way that the level of protection is affected. This shall include damage to cables, excessive number of connections, terminals not made to original specification, damage to seals, incorrect fitting of glands, etc.
- Ensure that seals or sealing materials have not degraded such that they no longer serve the purpose of preventing the ingress of flammable atmospheres.
- Replacement parts shall be in accordance with the manufacturer's specifications.
- Do not apply any permanent inductive or capacitance loads to the circuit without ensuring that this will not exceed the permissible voltage and current permitted for the equipment in use.
- Intrinsically safe components are the only types that can be worked on while live in the presence of a flammable atmosphere. The test apparatus shall be at the correct rating.
- Replace components only with parts specified by the manufacturer. Other parts may result in the ignition of refrigerant in the atmosphere from a leak.
- Check that cabling will not be subject to wear, corrosion, excessive pressure, vibration, sharp edges or any other adverse environmental effects. The check shall also take into account the effects of ageing or continual vibration from sources such as compressors or fans.
- When breaking into the refrigerant circuit to make repairs – or for any other purpose – conventional procedures shall be used. However, it is important that best practice is followed.
- Since flammability is a consideration. The following procedure shall be adhered to:
 - remove refrigerant;
 - purge the circuit with inert gas;
 - evacuate;
 - purge again with inert gas;
 - open the circuit by cutting or brazing.
- The refrigerant charge shall be recovered into the correct recovery cylinders. The system shall be "flushed" with OFN to render the unit safe. This process may need to be repeated several times. Compressed air or oxygen shall not be used for this task.
- Flushing shall be achieved by breaking the vacuum in the system with OFN and continuing to fill until the working pressure is achieved, then venting to atmosphere, and finally pulling down to a vacuum.
- This process shall be repeated until no refrigerant is within the system. When the final OFN charge is used, the system shall be vented down to atmospheric pressure to enable work to take place.
- This operation is absolutely vital if brazing operations on the pipe-work are to take place.
- Ensure that the outlet for the vacuum pump is not close to any ignition sources and there is ventilation available.
- Ensure that contamination of different refrigerants does not occur when using charging equipment. Hoses or lines shall be as short as possible to minimise the amount of refrigerant contained in them.
- Prior to recharging the system it shall be pressure tested with OFN.

- DD.12 Decommissioning:

Before carrying out this procedure, it is essential that the technician is completely familiar with the equipment and all its detail. It is recommended good practice that all refrigerants are recovered safely. Prior to the task being carried out, an oil and refrigerant sample shall be taken in case analysis is required prior to re-use of reclaimed refrigerant. It is essential that electrical power is available before the task is commenced.

1. Become familiar with the equipment and its operation.
 2. Isolate system electrically.
 3. Before attempting the procedure ensure that:
 - mechanical handling equipment is available, if required, for handling refrigerant cylinders;
 - all personal protective equipment is available and being used correctly;
 - the recovery process is supervised at all times by a competent person;
 - recovery equipment and cylinders conform to the appropriate standards.
 4. Pump down refrigerant system, if possible.
 5. If a vacuum is not possible, make a manifold so that refrigerant can be removed from various parts of the system.
 6. Make sure that cylinder is situated on the scales before recovery takes place.
 7. Start the recovery machine and operate in accordance with manufacturer's instructions.
 8. Do not overfill cylinders. (No more than 80 % volume liquid charge).
 9. Do not exceed the maximum working pressure of the cylinder, even temporarily.
 10. When the cylinders have been filled correctly and the process completed, make sure that the cylinders and the equipment are removed from site promptly and all isolation valves on the equipment are closed off.
 11. Recovered refrigerant shall not be charged into another refrigeration system unless it has been cleaned and checked.
- Equipment shall be labelled stating that it has been de-commissioned and emptied of refrigerant. The label shall be dated and signed. Ensure that there are labels on the equipment stating the equipment contains flammable refrigerant.
 - When removing refrigerant from a system, either for servicing or decommissioning, it is recommended good practice that all refrigerants are removed safely.
 - When transferring refrigerant into cylinders, ensure that only appropriate refrigerant recovery cylinders are employed. Ensure that the correct number of cylinders for holding the total system charge are available. All cylinders to be used are designated for the recovered refrigerant and labelled for that refrigerant (i.e. special cylinders for the recovery of refrigerant). Cylinders shall be complete with pressure relief valve and associated shut-off valves in good working order. Empty recovery cylinders are evacuated and, if possible, cooled before recovery occurs.
 - The recovery equipment shall be in good working order with a set of instructions concerning the equipment that is at hand and shall be suitable for the recovery of flammable refrigerants. In addition, a set of calibrated weighing scales shall be available and in good working order. Hoses shall be complete with leak-free disconnect couplings and in good condition. Before using the recovery machine, check that it is in satisfactory working order, has been properly maintained and that any associated electrical components are sealed to prevent ignition in the event of a refrigerant release. Consult manufacturer if in doubt.
 - The recovered refrigerant shall be returned to the refrigerant supplier in the correct recovery cylinder, and the relevant Waste Transfer Note arranged. Do not mix refrigerants in recovery units and especially not in cylinders.
 - If compressors or compressor oils are to be removed, ensure that they have been evacuated to an acceptable level to make certain that flammable refrigerant does not remain within the lubricant. The evacuation process shall be carried out prior to returning the compressor to the suppliers. Only electric heating to the compressor body shall be employed to accelerate this process. When oil is drained from a system, it shall be carried out safely.
 - Warning: disconnect the appliance from its power source during service and when replacing parts.
 - These units are partial unit air conditioners, complying with partial unit requirements of this International Standard, and must only be connected to other units that have been confirmed as complying to corresponding partial unit requirements of this International Standard.

02. Operation

02.01. Operation Precautions

WARNING

- If the unit will be not used for a long time, disconnect the main power switch. Otherwise, an accident may occur.
- The installation height of the air conditioner shall be at least 2.3m above the ground to avoid the following risks:
 1. Touching of moving or live parts, such as fans, motors, or louvers, by a non professional.
 2. Running parts may cause harm to you or transmission assemblies may become damaged.
- Getting too close to the air conditioner may reduce the level of comfort.
- When the product is used with a burning appliance, the room must be ventilated regularly. Otherwise, it may cause an insufficient oxygen supply.
- Do not let children play with the air conditioner. Otherwise, an accident may occur.
- Do not expose the Indoor Units or controller to moisture or water as this may cause short circuiting or fire.
- Do not place any appliance that uses an open flame in the direct air supply of the air conditioner as it could interfere with the combustion of the appliance.
- Do not use or store flammable gases or liquids such as natural gas, hair spray, paint or gasoline near the air conditioner. Otherwise, a fire may occur.
- To avoid causing harm, do not place animals or plants directly in front of the air conditioner's air supply.
- In the event of abnormal conditions such as abnormal noise, smell, smoke, temperature rise, and electric leakage, please cut off the power immediately, and then contact your local dealer or air conditioner customer service center. Do not repair the air conditioner by yourself.
- Do not place flammable sprayers near the air conditioner or spray it directly at the air conditioner. Otherwise, a fire may occur.
- Do not place a container of water on the air conditioner. If immersed in water, the air conditioner's electrical insulation will weaken, resulting in electrical shock.
- After long-term use, confirm whether the installation platform has become worn. If it is worn, the unit could fall, causing injury.
- Do not operate the switch with wet hands, as this may result in electric shock.
- When servicing the air conditioner, be sure to turn off the air conditioner and cut off the power supply. Otherwise, the high-speed operation of the internal fan will cause injury.
- The air conditioner cannot be used to preserve food, animals and plants, precision instruments and works of art, etc.; otherwise, quality degradation could occur.
- Do not place valuables under the air conditioner. Air conditioner condensation problems may damage the valuables.
- When the air conditioner needs to be moved and re-installed, please entrust the local dealer or a professional technician to operate it.

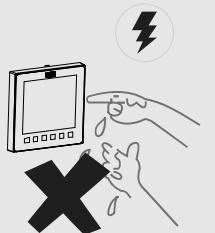
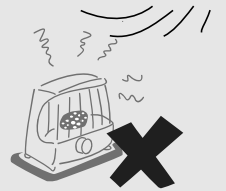

⚠ CAUTION

- To use the unit normally, please follow the "Operation" section in this manual. Otherwise, the internal protection may be triggered, the unit may begin to drip, or the unit's cooling and heating effects may be impacted.
- The room temperature should be set properly, especially when there are elderly, children, or patients in the room.
- Lightning or the starting and stopping of large electrical equipment in nearby factories may cause misoperation of the air conditioner. Please turn off the main power switch for a few seconds, and then restart the air conditioner.
- To avoid accidental resetting of the thermal circuit breaker, the air conditioner cannot be powered by an external switching device such as a timer or connected to a circuit that is turned on and off by a common component timer.
- Check whether the air filter is installed properly. Confirm that the inlet and outlet ports of the Indoor Unit/Outdoor Unit are not blocked.
- If the air conditioner will not be used for a long time, please clean the air filter before you start the air conditioner. Otherwise, dust and mold on the filter could contaminate the air or produce an unpleasant odor. For more details, please refer to the section "Cleaning and Maintenance".

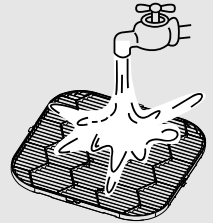
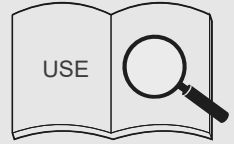
**02.02. Optimum Operation**

As cold air sinks and hot air rises, to improve the cooling and heating effect, it is recommended to have an angle of 30° to 65° between the louver and ceiling during cooling and heating.

**⚠ CAUTION**

Long-term air output at an angle of 40° may cause condensation on the surface of the louver. It is recommended to turn on the anti-condensation function through the wired controller to alleviate this situation.

Operating Range

To maintain good performance, operate the air conditioner under the following temperature conditions:

Cooling	Indoor Temperature	16~32 °C
	Indoor Humidity	≤80% (When the humidity exceeds 80%, long-time operation of the Indoor Unit may cause dew condensation on the surface of the Indoor Unit or generate mist-like cold air from the air outlet.)
Heating	Indoor Temperature	15~30°C

 **CAUTION**

The Indoor Unit operates stably within the temperature range given in the table above. If it exceeds this normal operating range, the Indoor Unit may stop running.

03. Symptoms That Are Not Faults

Normal Protection of the Air Conditioner

During operation, the following phenomena are normal and do not require maintenance.

Protection	When the power switch is on, if you start the system right after it is stopped, it is normal that the Outdoor Unit does not operate for about four minutes as frequent compressor start/stop is not supported.
Anti-cold air protection (Heat pump type)	In heating mode (including heating in automatic mode), when the indoor heat exchanger does not reach a certain temperature, the indoor fan temporarily shuts off, or runs in Low mode until the heat exchanger heats up to prevent the blowing of cold air.
Defrosting (Heat pump type)	When the outdoor temperature is low and the humidity is high, frost may build up on the Outdoor Units heat exchanger, which may reduce the heating capacity of the air conditioner. In this case, the air conditioner will stop heating, enter automatic defrosting mode, and return to heating mode after defrosting has been completed. During the defrosting, the outdoor fan stops running and the indoor fan runs using the anti-cold air protection function. The defrosting operation time varies depending on the outdoor temperature and the degree of frosting. It generally takes 2 to 10 minutes. During the defrosting process, the Outdoor Unit may emit steam due to the rapid defrosting, which is normal.
Anti Condensation	When the Indoor Unit detects high humidity, the air conditioner will adjust the louver angle and the fan speed to prevent condensation and avoid dripping. (If a third-party panel is selected, this function is not available.)

Normal Phenomena that Are Not Air Conditioner Faults

The following phenomena are normal during operation of the air conditioner. They can be solved according to the instructions below or do not need to be solved.

<p>The Indoor Unit emits white mist</p>	<ol style="list-style-type: none"> 1. In an environment where the indoor relative humidity is too high, when the Indoor Unit runs in cooling mode, white mist may appear due to the humidity and the temperature difference between the air inlet and outlet. 2. When the air conditioner is switched to heating mode after defrosting, the Indoor Unit discharges the moisture generated from defrosting as steam.
<p>The Indoor Unit blows dust</p>	<p>When the air conditioner has not been used for a long time or is used for the first time, the air filter should be cleaned. Otherwise, dust that has entered the Indoor Unit will be blown out.</p>
<p>The Indoor Unit emits odor</p>	<p>The Indoor Unit absorbs the odors of rooms, furniture or cigarettes, etc., and disperses the odors during operation. It is advised to have the air conditioner cleaned and maintained regularly by professional technicians.</p>
<p>Water drips on the air conditioner surface</p>	<p>When the indoor relative humidity is high, it is normal for condensation or slight water blowing to occur on the surface of the air conditioner.</p>
<p>"Self-cleaning" sound of icing</p>	<p>During self-cleaning, there may be a slight clicking sound for about 10 minutes, indicating that the Indoor Unit is freezing, which is normal.</p>
<p>The air conditioner makes low noise</p>	<ol style="list-style-type: none"> 1. When the air conditioner is in "Auto", "Cool", "Dry", and "Heat" modes, it may emit a low continuous "hissing" sound, which is caused by the refrigerant flowing between the Indoor Unit and the Outdoor Unit. 2. A "hissing" sound may be heard for a short time after the air conditioner stops operation or during "defrosting", which is caused when the refrigerant stops flowing or changes its flow. 3. When the air conditioner is in Cool mode or Dry mode, a small and continuous rustling sound can be heard, which is caused by the drain pump. 4. When the air conditioner starts or stops running, you may hear a squeaking sound which is produced by the expansion or shrinkage of parts or surrounding aesthetic materials due to temperature change. The sound will disappear when the air conditioner is running normally.
<p>Switching from cooling/heating (not available for cooling only units) mode to fan only mode</p>	<p>When the Indoor Unit reaches the set temperature, the air conditioner compressor automatically stops operation and switches to the fan only mode. When the room temperature rises (in cooling mode) or falls (in heating mode) to a certain level, the compressor is restarted and cooling or heating operation is resumed.</p>
<p>In winter, the outdoor temperature is low, and heating effects may be decreased</p>	<ol style="list-style-type: none"> 1. During the heating operation of the heat pump type air conditioner, the air conditioner absorbs heat from the outdoor air and releases it to heat the indoor air. This is the heat pump heating principle of the air conditioner. 2. When the heat pump runs in heating mode, the Outdoor Unit blows out cold air, causing the outdoor temperature to drop. When the outdoor temperature is extremely low, the heating capability of the air conditioner drops gradually. You are advised to use other heating devices for heating.
<p>No heating or cooling options</p>	<p>All Indoor Units in the same air conditioning system can only operate in the same mode, for example, cooling, heating, or others. Conflict may occur if Indoor Units are set to different modes. Only the Indoor Unit that is first started up can determine the operating mode, and those started after it can only follow the operating mode of the first Indoor Unit. To change the operating mode, you need to turn off all the Indoor Units. The operating mode of all Indoor Units must be the same.</p>

04. Display panel

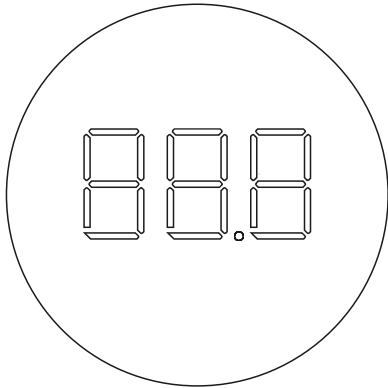

Display functions:

1. In Standby mode, the main interface displays “---”.
2. When starting up in Cooling or Heating mode, the main interface displays the set temperature. In Fan mode, the main interface displays the indoor temperature. In Dry mode, the main interface displays the set temperature, and when the humidity is set, the set humidity value is displayed on the wired controller.
3. The light display on the main interface can be turned on or off through the light button on the remote controller.
4. When the system fails or runs in a special mode, the main interface displays the error code or the special mode running code. For details, see the section “Error Codes and Meanings”.

CAUTION

Some display functions are available only for certain Indoor Unit and outdoor Unit models, wired controllers, and display boxes. For more information, please consult your local dealer or technical support.

05. Cleaning and Maintenance

05.01. Safety Warning

WARNING

For safety reasons, always turn off the air conditioner and turn off the power before cleaning the air conditioner.

Do not disassemble or repair the air conditioner by yourself; otherwise, it may cause fire or other hazards.

Only professional service personnel can carry out the maintenance.

Do not use flammable or explosive materials (such as hair styling agents or pesticides) near the product.

Do not use organic solvents such as paint thinner to clean this product; otherwise, it may cause cracks, electric shock or fire.

Only qualified dealers and professionally qualified electricians can install the optional accessories.

Be sure to use the optional accessories specified by our company.

Improper installation by yourself may result in water leakage, electric shock or fire.

Do not wash the air conditioner with water; otherwise, it may cause an electric shock.

Use a stable standing platform.

05.02. Cleaning the Air Filter

CAUTION

- Air filters can be used to remove dust or other particles from the air, and if clogged, the effectiveness of the air conditioner will be greatly reduced.
- Therefore, be sure to clean the air filter frequently when using it for an extended period.
- For the Indoor Unit with constant speed mode, if it is installed in a place with a lot of dust, it is recommended that you clean the filter once a month.
- For Indoor Units with a constant air flow mode, clean the filter when you receive the reminder of the wired controller.
- If excess dirt makes the filter difficult to clean, replace the filter.
- Do not remove the air filter unless it is being cleaned; otherwise, it may cause malfunction.
- If the air conditioner is used without an air filter, the accumulation of dust in the air conditioner will often cause malfunctions due to the failure to remove dust from the indoor air.

Procedure:

1. Remove the air inlet grille.
Press the grille clamp with two fingers at the same time, and pull out the air inlet grille in a downward direction.

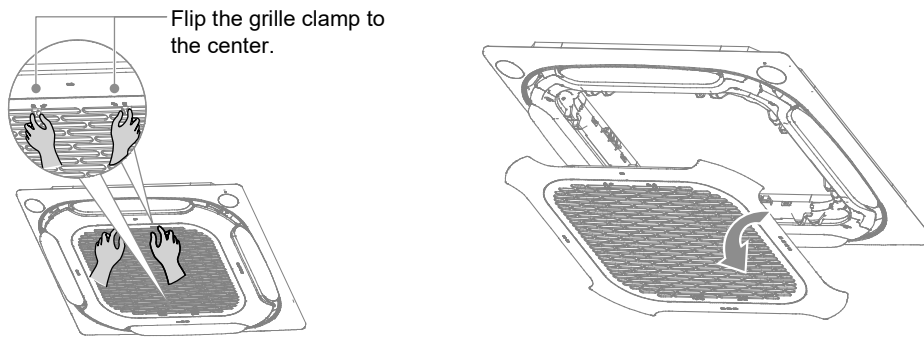

2. Remove the filter.

NOTE

Only professionals can change and disassemble the filter. Any improper operations may cause electric shock or injuries due to touching rotating parts.

3. Clean the filter.

Clean the filter with a vacuum cleaner, with the air inlet side of the filter facing upwards.

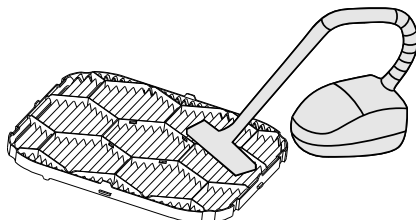

Clean the filter with clean water (except for the activated carbon module), with the air inlet side of the filter facing downwards.

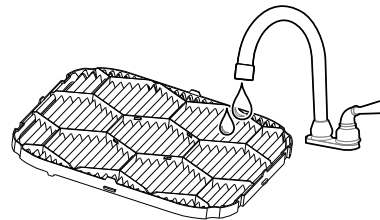

NOTE

- Do not dry the filter in direct sunlight or fire to avoid deformation of the filter.
- If the filter is heavily soiled, use a soft brush and neutral detergent to clean it, then shake off the water and dry it in a cool place.
- Non-professionals should not disassemble, replace or repair the filter.

4. Reinstall the filter.
5. Reinstall and close the air inlet grille by following steps 1 and 2 above in reverse.

05.03. Cleaning Air Outlets and Exteriors Panels

1. Wipe the air outlet and panel with a dry cloth.

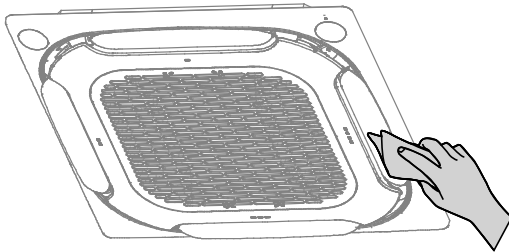

2. If a stain is hard to remove, clean it with clean water or neutral detergent.

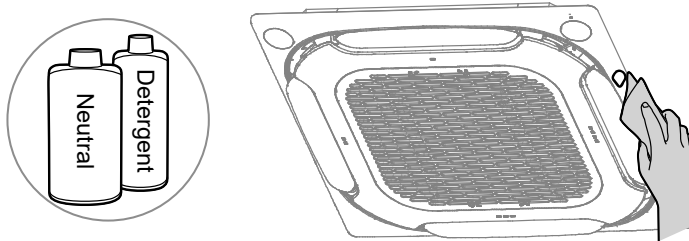
**⚠ CAUTION**

- Do not use gasoline, benzene, volatile agents, decontamination powder or liquid insecticides. Otherwise, the air outlet or panel may become discolored or deformed.
- Do not expose the inside of the Indoor Unit to moisture, as it may result in electric shock or fire.
- When cleaning the louver with water, do not scrub it violently.
- If the air conditioner is used without an air filter, the accumulation of dust in the air conditioner will often cause malfunctions due to the failure to remove dust from the indoor air.

05.04. Maintenance

1. During in-depth maintenance, the air conditioner should be cleaned and maintained by professional technicians every 2 to 3 years.
2. Clean the filter regularly.
When operating in a dusty environment, the air flow and capacity of the filter will decrease. The filter may even become blocked, and the air conditioner performance and indoor air compromised.
3. Preheat the unit in advance.
When the heating season comes, power on the outdoor Unit master unit for preheating more than 4 hours before use. The preheating time depends on the weather temperature. This can make the air conditioner operate more stably and help the refrigeration oil in the air conditioner compressor to maintain the best lubrication state, which can prolong the service life of the compressor.
4. Complete the following steps before the air conditioner is put out of use for a long period:
 - If the air conditioner is not in use for a long time due to seasonal changes, keep the unit running for 4-5 hours in fan mode until the unit becomes completely dry. Otherwise, it may grow mold indoors and have negative health effects.
 - When not in use for a long time, power off or unplug the power plug to reduce standby power consumption, and wipe the wireless remote controller with a clean soft dry cloth and remove the battery.
 - Turn on the power switch 12 hours before using the air conditioner again. In addition, in seasons when air conditioners are frequently used, keep the power switch on. Otherwise, failures may occur.

CAUTION

- Before the air conditioner is idle for a long time, the internal components of the outdoor Units should be checked and cleaned regularly. For more details, please contact the customer service or special technical service department.
- Check the return air inlet and outlet of the outdoor Unit and Indoor Unit after long periods of use to see if they are blocked; if an inlet/outlet is blocked, clean it immediately.

06. Maintenance Frequency Checklist

Regular servicing of equipment by a qualified technician is recommended every 12 months for residential applications and every quarter for commercial applications. Regular servicing of your unit helps in maintaining its optimum performance and reliability. **The following checklist and service periods are provided as a guide only, as some sites may require more frequent servicing.**

ELECTRICAL										
Parts	Service Period								Detail of Service Check	Service Methods
	1 Mth	3 Mth	6 Mth	1 Yr	2 Yrs	3 Yrs	4 Yrs	5 Yrs		
Printed Circuit Boards				✓					Visual Inspection	Tighten Terminals as necessary on printed circuit boards
Electrical Connections				✓					Check all electrical terminals, mains, communications, etc	Re-tighten if loose.

INDOOR UNIT										
Parts	Service Period								Detail of Service Check	Service Methods
	1 Mth	3 Mth	6 Mth	1 Yr	2 Yrs	3 Yrs	4 Yrs	5 Yrs		
Casing / Panels and Frames				✓					Visual check for damage, rust and dust accumulation.	For highly corrosive environment, wash panels quarterly with water and neutral detergent solution. Wax panels. Repair / re-paint where required.
Insulation				✓					Visual check for insulation conditions.	Repair / replace insulation material.
Fan				✓					Visual check for run out of balance and dust attached	Clean off dust as necessary to negate possibility of fan running out of balance
Motor				✓ Ω					Visual check on wiring. Insulation resistance check to be carried out annually	Measure insulation resistance. Reading should be more than 1MΩ.
Heat Exchanger				✓					Check for clogging by dust. Check for leaks / damage.	Clean air inlet side as necessary. Straighten any bent fins using fins comb.
Drain Pan/ Condensation line				✓					Check for obstructions and free flow of water	Clean to eliminate obstructions/ sludge and check condition of pan. Pour water to ensure flow
Filter*		✓							Check for clogging by dust.	Clean Filter
Temperature Readings				✓					Measure air on and air off	Place temperature probe in return and supply air of unit.
Damper Motors (if fitted)				✓					Visual inspection of motors open/closing. Ensure no obstructions	Drive motors opened and closed. Ensure correct operation
Duct Works				✓					Inspect duct works for air gaps.	Re-tape any loose ducts.

* Service period for filter cleaning may vary depending on operating time and surrounding environment.

THIS PAGE WAS INTENTIONALLY LEFT BLANK



actronair.com.au

1300 522 722



©Copyright 2023 Actron Engineering Pty Limited ABN 34 002767240. ®Registered Trade Marks of Actron Engineering Pty Limited. ActronAir is constantly seeking ways to improve the design of its products. Therefore, specifications are subject to change without notice.